



Product Catalogue

Version 3.0



At **PVezRack®** our heritage is founded on the art of engineering and a culture of collaboration. We've built our legacy with a future focus that still stays true to the fundamentals of sustainable design. We have built a collaborative culture amongst stakeholders from across our industry, which was critical for us to deliver on our mission. We offer the solar industry, versatile mounting equipment for every application.

PVezRack® is the flagship product line from Clenergy, which has been designing products since 2007 and has grown into an Australian solar industry icon with its products sold across 30 countries. Our ongoing research and development is backed by a culture of open innovation, excellence through quality and being service focused.

We develop for optimal functionality, with an emphasis on simplicity for aesthetically brilliant projects. Our technically advanced solar mounting gear is complemented by unique kliplok clamps and accessories, as well as our unparalleled logistics & operations team, with an emphasis on customer service.



Clenergy is a veteran manufacturer with startup roots in Melbourne, Australia, we have earned a solid reputation throughout the nation and across APAC, because of a proven track record of success. We bring our expertise to the table to provide your company and engineers with creative insights, and attention to detail.

List of contents

Milestones	3
SolarRoof	4 - 17
ThinFilm	18 - 19
SolarTripod	20 - 23
SolarTripod Lite	24 - 25
SolarBase	26 - 27
ComT	28 - 31
ComT 2.0	32 - 35
SolarTerrace II-A	36 - 39
SolarTerrace III-A	40 - 43
SolarTerrace V	44 - 47
PostMount 1-A, 2-A, 3-A, 4-A	48 - 51
PostMount 6-A, 8-A	52 - 53
PostMount 1-A, 2-A, 3-A for XL Panels	54 - 57
PostMount 4-A, 6-A for XL Panels	58 - 61
ezShade	62 - 65
Accessories	66 - 70
Product Warranty	71 - 73
Merch Store	74 - 75

Key Facts

Market Value

Founded in 2007
 Public listed on the Shanghai Stock Exchange in 2017
 Strategic investment by China famous state-owned enterprises

Industry Leader

12GW of worldwide installations
Top 5 Solar Tracker Supplier in China
 Largest share of the rooftop solar PV market in AU for 12 years
 13 billion+ kWh green power generation capacity annually

Core Business

Global offering of solar products
 Solar PV + Smart Energy Solution
610,000+ rooftop solar projects
10,000+ solar plants

Milestones



2021-Current New Heights

Clenergy enters the building industry with cable management solutions, and launches the RUNNUR brand.

Clenergy sealed a strategic partnership with Xiamen C&D Inc. and Xiamen Lide Group.

Launched country-wide distributed rooftop pilot program across Xiang'an district backed by the National Energy Administration.

Clenergy rebrands to reflect our new vision and mission.



2011-2015 Global Expansion - Diversified Development

Added a Tianjin manufacturing base.

New Official Subsidiaries – Australia, US, Japan, Thailand and the Philippines.

Business Model – Global Market + Local Service + Global Supply Chain.



2007-2008 Startup - Foundation

Founded Manufacturing in Xiamen, China. Developed the Australian market. Great Industry brand awareness.

2016-2020 Public Listing

IPO application approved by the CSRC in 2016.

Successfully listed in the Shanghai Stock Exchange in 2017.

Doubled the sales volume in 2018, reaching 1.7GW.

Cooperated with Obton and Hunan Xinhua on 65MW and 77.1MW solar project respectively in 2019.

Pipeline of more projects across Asia, Japan, Germany & Australia.

Annual shipments reached 2GW in 2020; Bagged 293MW order in Shihezi, Xinjiang, making it the largest solar tracker project within China in 2020.

2009-2010 Turning Pointing

Successfully developed the "PV-ezRack" series.

Lead to Australia's No.1 Solar Mounting Equipment supplier.



SolarRoof

Reliable, robust roof mounting system with high quality components designed for the harshest conditions.

PV-ezRack® SolarRoof has been developed for both residential and commercial PV installations on tin and tile roofs. The components are easy to install and can be used for flush as well as tilted systems, on a large variety of roof types. The interfaces, rails and clamps use high quality, robust and corrosion resistant materials including structural grade aluminium alloy (AL6005-T5) and stainless steel (SUS304).

Main Benefits

Quick and Easy Installation

Innovative and internationally patented, the Z-Module and Click Module technology are used in almost all SolarRoof components. The Z-Module and Click Module quick provide easy and safe installation method. They can be inserted into the rail at any given point, and secured with just two or three hand grips.

Versatility

A large variety of roof hooks, tin roof fixings, tilt legs and adapters help ensure that you will find a suitable fixing method for almost every roof, where fixing with penetration is required.

Wide Range of Tilting

With three adjustable tilt legs, these parts can tilt panels from between 10-60 degrees. Through its innovative design, the tilt legs can cope with all common purlin distances.

Universal

SolarRoof has suitable inter and end clamps for every size of solar panel including frameless, thin film panels or special clamps for cyclonic regions. In the growing range of clamps, cable clips, adapters and accessories you are sure to find the parts you require for your residential or commercial rooftop mounting needs.

**10 Year
Warranty**

Commercial

Residential

Tile Roof

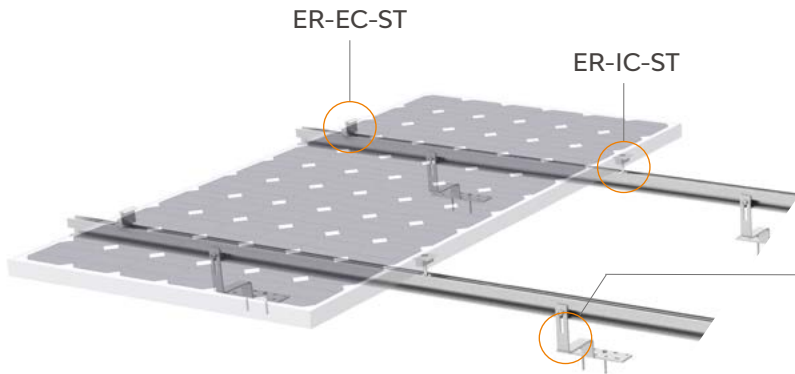

- ER-I-01
- ER-I-02
- ER-I-04
- ER-I-23
- ER-I-26
- ER-I-51
- ER-I-41/EZC/ECO
- ER-I-61/EZC/ECO

Tin Roof

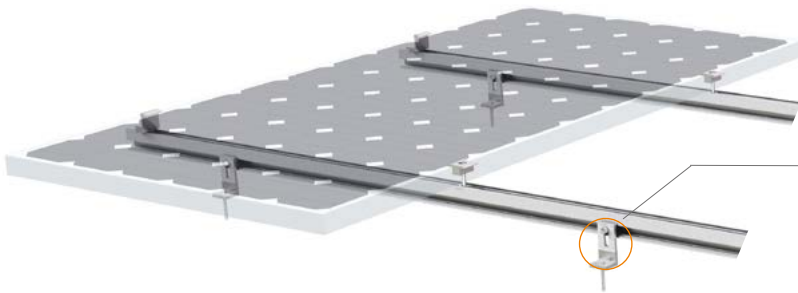

- ER-I-05
- ER-I-05/BA
- ER-I-05/CM
- ER-I-05A/EZC/ECO
- ER-I-25
- ER-I-25/BA

Tin Roof (Tilt Legs)

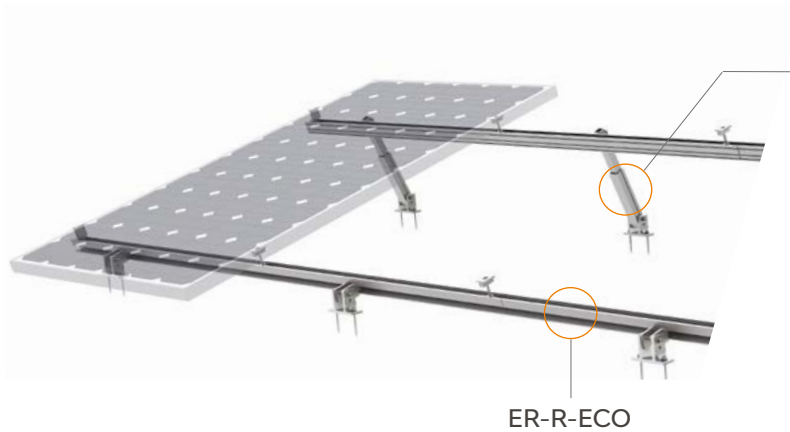

- ER-TL-5/PS
- ER-TL-10/PS
- ER-TL-10/15
- ER-TL-15/30
- ER-TL-30/60
- ER-TL-10/15/PS
- ER-TL-15/30/PS
- ER-TL-10/15/BA
- ER-TL-15/30/BA
- TL-10/15/L/PS
- TL-15/30/L/PS

Available accessories

- Grounding/earthing
- Cable clips
- Rail caps
- Isolator Shade

SolarRoof Non-penetrative

Reliable, robust roof mounting system with high quality components designed for concealed-fix roof claddings (Klip-lok, Longline).

To achieve and maintain improved watertightness of solar installations on Klip-lok type tin roofs, PV-ezRack® SolarRoof has been expanded with a range of nonpenetrative brackets. Rigorous testing on real size roofing sheets ensures safety, compliance and structural integrity of the PV-installations. As a result, the Kliplok type brackets can be used for installing flush to the roof as well as for tilted systems.

Main Benefits

No Roof Penetration

Watertightness is easily maintained with the SolarRoof clamps for concealed fix roofs, as there is no need for roof penetration. With Clenergy's thorough testing methods, this is made possible without any compromises on safety or structural integrity.

Versatility

The non-penetrative clamps can be used for flush installations as well as for tilting. The fixing method for flush mounting include using our L-feet interface with rails and clamps, all fixed on top of the non-penetrative clamps. For tilted systems, the adjustable tilt legs or SolarTripod can be used directly on the compatible non-penetrative clamps.

Quick and Easy Installation

Innovative and internationally patented, the Z-Module and Click Module technology are used in almost all SolarRoof components. The pre-assembled legs, Z-Module and Click Module quick provide easy and safe installation method. They can be inserted into the rail at any given point, and secured with just two or three hand grips. The parts you require for your residential rooftop mounting needs.

**10 Year
Warranty**

Commercial

Residential

Tin Roof

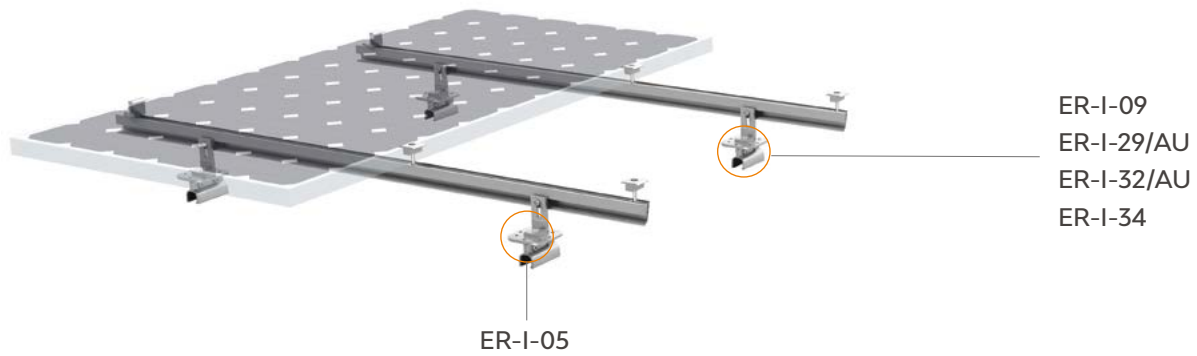

Tin Roof (Tilt Legs)

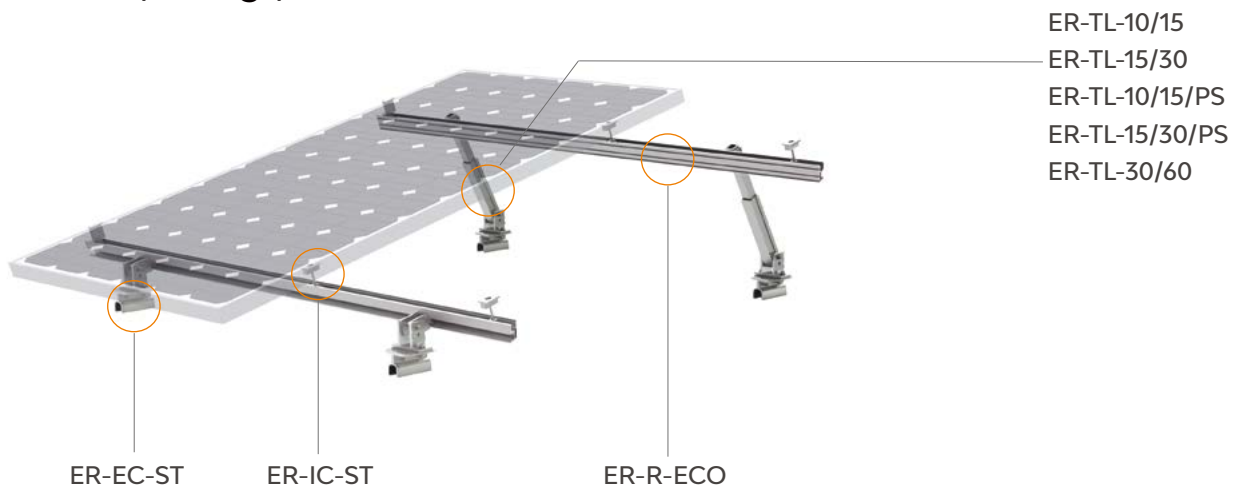

Available accessories

- Grounding/earthing
- Cable clips
- Rail caps
- Isolator Shade

SolarRoof - Black Anodized

Reliable, robust roof mounting system with high quality components designed for the harshest conditions.

PV-ezRack® SolarRoof is an universal mounting system for PV installation on roof, which is available for black and silver. The components are easy to install and can be used for flush as well as tilted systems, on a large variety of roof types. The interfaces, rails and clamps use high quality, robust and corrosion resistant materials including structural grade aluminium alloy (AL6005-T5) and stainless steel (SUS304).

Main Benefits

Quick and easy installation

Innovative and internationally patented, the Z-Module technology is used in almost all SolarRoof components. The Z-Module provides a quick, easy and safe installation method. It can be inserted in to the rail at any given point, and secured with just three hand grips.

Versatility

A large variety of tin roof fixings, tilt legs and adapters help ensure that you will find a suitable fixing method for almost every roof, where fixing with or without penetration is required.

Wide range of tilting

With three adjustable tilt legs, these parts can tilt panels from between 10-60 degrees. Through its innovative design, the tilt legs can cope with all common purlin distances.

Universal

SolarRoof has suitable mid and end clamps for every size of solar panel including frameless, thin film panels or special clamps for cyclonic regions. In the growing range of clamps, cable clips, adapters and accessories you're sure to find the parts you require for your residential rooftop mounting needs.

10 Year
Warranty

Commercial

Residential

International Patent
PCT/AU2009/000616



Available accessories

- Isolator Shade
- Rail caps

SolarRoof - Black Anodized

Non-penetrative

Reliable, robust roof mounting system with high quality components designed for concealed-fix roof claddings (Klip-lok, Longline).

To achieve and maintain improved watertightness of solar installations on Kliplok type tin roofs, PV-ezRack® SolarRoof has been expanded with a range of nonpenetrative brackets. Rigorous testing on real size roofing sheets ensures safety, compliance and structural integrity of the PV-installations. As a result, the Klip-lok type brackets can be used for installing flush to the roof as well as for tiled systems.

Main Benefits

No roof penetration

Watertightness is easily maintained with the SolarRoof clamps for concealed fix roofs, as there's no need for roof penetration. With Clenergy's thorough testing methods, this is made possible without any compromises on safety or structural integrity.

Versatility

The non-penetrative clamps can be used for flush installations as well as for tilting. The two fixing methods for flush mounting include direct mounting** (no rails) and bracket plus L-feet (with rails). For tilted systems, the adjustable tilt legs or SolarTripod can be used directly on the compatible nonpenetrative clamps.

Quick and easy installation

Innovative and internationally patented, the Z-Module technology is used in almost all SolarRoof components. The Z-Module provides a quick, easy and safe installation method. It can be inserted in to the rail at any given point, and secured with just three hand grips.

**10 Year
Warranty**

Commercial

Residential

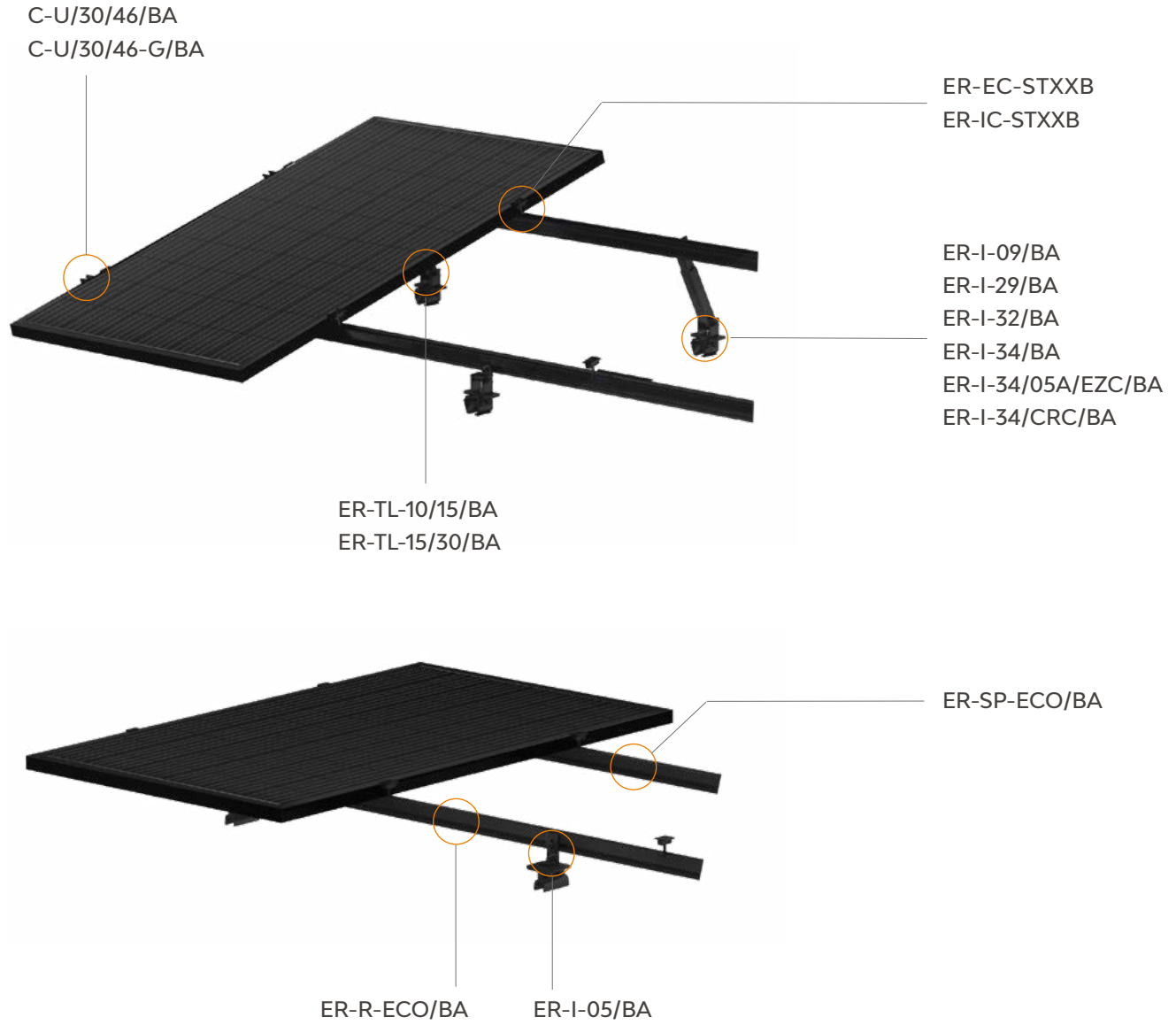





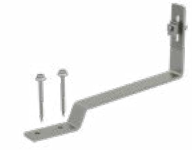

Available accessories

- Isolator Shade
- Rail caps

Components

	<p>ER-I-41/EZC/ECO Adjustable Tile Interface with ezclick connection, 120mm horizontal arm</p>	<ul style="list-style-type: none"> - Main part of Adjustable Tile Interface, 120mm horizontal arm - Base plate of Adjustable Tile Interface - L bracket for SRP interface - Clamp 1 for ECO-Rail - Clamp 2 for ECO-Rail - ezClip Spring - Lock Washer M8 x 18 - Hexagon socket button head screw M8 x 20 - Washer 8 - Plain washer 8 - Hexagon socket head cap screw M8 x 16 - Hexagon socket head cap screw M8 x 25 - Buildex 14-10 x 65 Hex Head Zips screw
	<p>ER-I-61/EZC/ECO Adjustable Tile Interface with ezclick connection, 170mm horizontal arm</p>	<ul style="list-style-type: none"> - Main part of Adjustable Tile Interface, 170mm horizontal arm - Base plate of Adjustable Tile Interface - L bracket for SRP interface - Clamp 1 for ECO-Rail - Clamp 2 for ECO-Rail - ezClip Spring - Lock Washer M8 x 18 - Hexagon socket button head screw M8 x 20 - Washer 8 - Plain washer 8 - Hexagon socket head cap screw M8 x 16 - Hexagon socket head cap screw M8 x 25 - Buildex 14-10x65 Hex Head Zips screw
	<p>ER-I-01 Tile Interface</p>	<ul style="list-style-type: none"> - Tile Roof Hook 1 - Z-Module - Washer 8mm (5/16") - Lock washer 8mm (5/16") A2 - Hex Socket Head Bolt M8 x 25mm (5/16" x 63/64") 933 A2-70 - Buildex 14-10 x 65 Hex Head Zips screw
	<p>ER-I-01/EZC/ECO Tile Interface with ezClick connection for ECO-Rail</p>	<ul style="list-style-type: none"> - Tile Roof Hook1 - Clamp 1 for ECO-Rail - Clamp 2 for ECO-Rail - ezClip Spring - Lock washer M8 x 18 - Hexagon socket head cap screw M8 x 28 - Buildex 14-10 x 65 Hex Head Zips screw
	<p>ER-I-01/CS Tile Interface, Carbon Steel</p>	<ul style="list-style-type: none"> - Tile Roof Hook1 (Carbon Steel) - Z Module - Washer 8 - Lock washer M8 - Hexagon socket head cap screw M8 x 25 - Buildex 14-10 x 65 Hex Head Zips screw

	<p>ER-I-02 Flat Tile Interface</p>	<ul style="list-style-type: none"> - Flat Tile Roof Hook - Z-Module - Washer 8mm (5/16") - Lock Washer 8mm (5/16") - Hex Socket Head Bolt M8 x 25mm (5/16"x 63/64") - Buildex 14-10x65 Hex Head Zips screw
	<p>ER-I-04 Slate Interface</p>	<ul style="list-style-type: none"> - Slate Roof Hook - Z-Module - Washer 8mm - Lock Washer 8mm A2 - Hex Socket Head Bolt M8 x 25mm - Buildex 14-10x65 Hex Head Zips screw
	<p>ER-I-23 Tile Interface - Landscape</p>	<ul style="list-style-type: none"> - Tile Roof Hook 3 - Z-Module - Washer 8 DIN 9021 A2 - Lock Washer 8mm A2 - Hex Socket Head Bolt M8 x 25mm 933 A2-70 - Buildex 14-10x65 Hex Head Zips screw
	<p>ER-I-26 Tile Interface - Side Mount</p>	<ul style="list-style-type: none"> - Tile Roof Hook 2 - Z-Module - Washer 8mm - Lock Washer 8mm - Hex Socket Head Bolt M8 x 25mm - Buildex 14-10 x 65 Hex Head Zips screw
	<p>ER-I-51 Tile Interface, 118mm horizontal arm, with BX screw 6.3x65</p>	<ul style="list-style-type: none"> - Tile Roof Hook with 118mm horizontal arm - Z Module (Anodized) - Washer 8 - Lock washer M8 x 18 - Hexagon socket head cap screw M8x25 - Buildex 14-10 x 65 Hex Head Zips screw
	<p>ER-I-05 ER-I-05/BA Tin Interface</p>	<ul style="list-style-type: none"> - Tin Roof Hook - Rubber Pad 38 x 38 x 2 - Z-Module - Washer 8mm - Lock Washer 8mm A2 - Hex Socket Head Bolt M8 x 28mm - Buildex 14-11 x 70 Hex Head Zips screw
	<p>ER-I-05/CM Tin Interface with Click Module Assembly</p>	<ul style="list-style-type: none"> - Tin Roof Hook - Rubber Pad 38 x 38 x 2 - Main Click Module - Side Click Module - Washer 8 - Lock Washer M8 x 18 - Hexagon socket head cap screw M8 x 28 - Buildex 14-11 x 70 Hex Head Zips screw - Spring for Click Module

	<p>ER-I-05A/EZC/ECO Tin Interface A with ezClick connection for ECO-Rail</p>	<ul style="list-style-type: none"> - Tin Roof Hook A - Rubber Pad 38 38 2 - Clamp 1 for ECO-Rail - Clamp 2 for ECO-Rail - ezClip Spring - Lock washer M8 x 18 - Hexagon socket head cap screw M8 x 28 - Buildex 14-11 x 70 Hex Head Zips screw
	<p>ER-I-25 ER-I-25/BA Tin Interface with Curved Base for Corrugated Roof (Z Module + Bolt + Universal Screw)</p>	<ul style="list-style-type: none"> - L-shaped Corrugated Tin Feet Base - Rubber Pad 55 x 40 x 2 - Z Module (Anodized) - Washer 8 - Lock washer M8 x 18 - Hexagon socket head cap screw M8 x 28 - Buildex 14-11 x 70 Hex Head Zips screw
	<p>EZ-AD-C43 EZ-AD-C43/BA Adapter (Puck) for Corrugated Iron Roof, with EPDM, for Tin Interface ERI-05</p>	
	<p>ER-I-09 ER-I-09/BA Klip Lok Interface 400-700HS</p>	<ul style="list-style-type: none"> - Main Hook - Side Hook - Hex Socket Head Bolt M8x25mm - Lock Washer M8 - Washer 8 - Rubber pad 65 x 100 x 2
	<p>ER-I-29/AU ER-I-29/BA Klip-lok Interface for longline 305</p>	<ul style="list-style-type: none"> - Main Hook for Klip-lok Interface for longline 305 - Side Hook for Klip-lok Interface for longline 305 - Rubber Pad for Klip-lok Interface for longline 305, L100 x 83 - Hexagon socket head cap screw M8 x 30 - Washer 8 - Plain washer 8 - Hexagon socket head cap screw M8 x 25 - Lock washer M8
	<p>ER-I-32/AU ER-I-32/BA Klip-lok Interface 406 with U-opening</p>	<ul style="list-style-type: none"> - Main Hook for Klip-lok Interface 406 with U-opening - Side Hook for Klip-lok Interface 406 with U-opening - Rubber Pad 55 x 100 x 2 - Washer 8 - Hexagon socket head cap screw M8 x 25 - Plain washer 8
	<p>ER-I-34 ER-I-34/BA Universal Klip-lok Interface</p>	<ul style="list-style-type: none"> - Main Hook of Universal Klip-lok Interface - Side Hook of Universal Klip-lok Interface - Hexagon socket head cap screw M8 x 80 - Hexagon socket head cap screw M8 x 25 - Washer 8 - Plain washer 8 - Hexagon nut M8 - O rubber rings Ø 10 x 1.9



ER-I-34/CRC
ER-I-34/CRC/BA

Universal Klip-lok Interface
pre-assembly with
Cross Connector Clamp

- Main Hook of Universal Klip-lok Interface
- Side Hook of Universal Klip-lok Interface
- Hexagon socket head cap screw M8 x 80
- Hexagon socket head cap screw M8 x 25
- Washer 8
- Plain washer 8
- Hexagon nut M8
- Cross Connector Clamp of ECO-Rail
- O rubber rings $\varnothing 12 \times 3$



ER-I-34/05A/EZC
ER-I-34/05A/EZC/BA

Universal Klip-lok Interface
pre-assembly with Tin Interface
A with ezClick module

- Main Hook of Universal Klip-lok Interface
- Side Hook of Universal Klip-lok Interface
- Hexagon socket head cap screw M8 x 80
- Hexagon socket head cap screw M8 x 25
- Washer 8
- Plain washer 8
- Hexagon nut M8
- O rubber rings $\varnothing 12 \times 3$
- Tin Roof Hook A
- Clamp 1 for ECO-Rail
- Clamp 2 for ECO-Rail
- ezClip Spring
- Lock washer M8 x 18
- Hexagon socket head cap screw M8 x 28



ER-TL-5/PS
ER-TL-10/PS

Fixed Tilt Legs, 5 degree,
10 degree, pre-assembled

- Front Leg Bracket (Anodized)
- Fix foot II (Anodized)
- L-feet (Anodized)
- Leg Strug II-167/261 (Anodized)
- Z Module (Anodized, grounding)
- Z Module (Anodized)
- Buildex 14-11 x 70 Hex Head Zips screw
- Hexagon socket head cap screw M8 x 25
- Hexagon socket head cap screw M8 x 28
- Hexagon socket head cap screw M8 x 55
- Hexagon socket head cap screw M8 x 65
- Hexagon nut M8
- Washer 8
- Rubber Pad 40 x 25 x 2
- Corrugated shim with hook (t3.5)
- External Teeth Lock Washer 8



ER-TL-10/15
ER-TL-15/30
ER-TL-30/60
ER-TL-10/15/PS
ER-TL-15/30/PS
ER-TL-10/15/BA
ER-TL-15/30/BA

Adjustable Tilt legs
 10-15 degree,
 15-30 degree,
 30-60 degree



- Front Leg Bracket (Anodized)
- Fix foot II (Anodized)
- L-feet (Anodized)
- Leg Strug II-220/350/635 (Anodized)
- Leg tube II-220/350/635 (Anodized)
- Z Module (Anodized, grounding)
- Z Module (Anodized)
- Buildex 14-11 x 70 Hex Head Zips screw
- Hexagon socket head cap screw M8 X 25
- Hexagon socket head cap screw M8 X 28
- Hexagon socket head cap screw M8 X 40
- Hexagon socket head cap screw M8 X 65
- Hexagon nut M8
- Washer 8
- Plain washer 8
- Hexagon socket head cap screw M8 X 16
- Rubber Pad 40 X 25 X 2
- Corrugated shim with hook (t3.5)
- Corrugated shim, 46 x 22mm (grounding)
- External Teeth Lock Washer 8



TL-10/15/L/PS
TL-15/30/L/PS

Adjustable Tilt Legs with L-feet,
 preassembly

- L-feet (Anodized)
- Leg Strug II-220/350 (Anodized)
- Leg tube II-220/350 (Anodized)
- Z Module (Anodized, grounding)
- Z Module (Anodized)
- Buildex 14-11 X 70 Hex Head Zips screw
- Hexagon socket head cap screw M8 X 28
- Hexagon socket head cap screw M8 X 40
- Hexagon socket head cap screw M8 X 65
- Hexagon nut M8
- Washer 8
- Plain washer 8
- Hexagon socket head cap screw M8 X 16
- Rubber Pad 38 X 38 x 2
- Corrugated shim with hook (t3.5)
- Corrugated shim, 46 x 22mm (grounding)
- External Teeth Lock Washer 8
- Tin Roof Hook for Tilt Leg



ER-R-ECO
ER-R-ECO/BA
 ECO-Rail

- With standard lengths 3600mm and 4400mm



R-ECO/XXXX/AUMF
 Australian Made Cutter Rail

- With standard lengths
 4200mm / 4400mm

	<p>ER-SP-ECO ER-SP-ECO/BA Splice for ECO-Rail</p>	<ul style="list-style-type: none"> - Splice with a standard length of 200mm - Hexagon socket head cap screw M8 x 12
	<p>SCO-ECO/380 Side Channel Cover for Cutter-Rail, length 380 mm</p>	
	<p>C-U/30/46 C-U/30/46/BA Universal Clamp for Frame Height 30-46mm</p>	<ul style="list-style-type: none"> - Universal Clamp - Module for Universal Clamp - Hexagon Socket Button Head Screw M8 x 55 - Washer 8 - Spring for Universal Clamp
	<p>C-U/30/46-G C-U/30/46-G/BA Universal Clamp for Frame Height 30-46mm with Grounding Clip</p>	<ul style="list-style-type: none"> - Universal Clamp - Module for Universal Clamp - Grounding Clip for Universal Clamp - Hexagon socket button head screw M8 x 55 - Washer 8 - ezClip Spring
	<p>ER-EC-DU35/40 End Clamp, Dual 35 or 40mm</p>	<ul style="list-style-type: none"> - End Clamp, Dual 35 or 40mm - Z Module (Anodized) - Washer 8 - Hexagon socket head cap screw M8 x 35
	<p>ER-EC-DU40/46 End Clamp, Dual 40 or 46mm</p>	<ul style="list-style-type: none"> - End Clamp, Dual 40 or 46mm - Z Module (Anodized) - Washer 8 - Hexagon socket head cap screw M8 x 35
	<p>ER-EC-ST ER-EC-ST/BA End Clamp, Standard</p>	<ul style="list-style-type: none"> - End Module Clamp 28mm, 32mm, 35mm, 38mm, 40mm, 42mm, 46mm, 48mm, 50mm - Z-Module - Hex Socket Head Bolt A2-70 M8 x 28 - Washer 8
	<p>ER-IC-ST ER-IC-ST/BA Inter Clamp, Standard</p>	<ul style="list-style-type: none"> - Inter Module Clamp 28mm, 35mm, 38mm, 40mm, 46mm, 50mm, 57mm - 28mm with Hex Socket Head Bolt A2-70 M8 x 40mm - 35mm with Hex Socket Head Bolt A2-70 M8 x 45mm - 38mm with Hex Socket Head Bolt A2-70 M8 x 50mm - 40mm with Hex Socket Head Bolt A2-70 M8 x 50mm - 46mm with Hex Socket Head Bolt A2-70 M8 x 55mm - 50mm with Hex Socket Head Bolt A2-70 M8 x 60mm - 57mm with Hex Socket Head Bolt A2-70 M8 x 70mm - Z-Module - Washer 8

ThinFilm

Designed for thin film and frameless or double glass PV-panels

Clenergy clamps for frameless panels are suitable for most thin film and most frameless or double glass PV-panels. Furthermore the clamps are compatible with all PV-ezRack® rails for roof and ground mount installations.

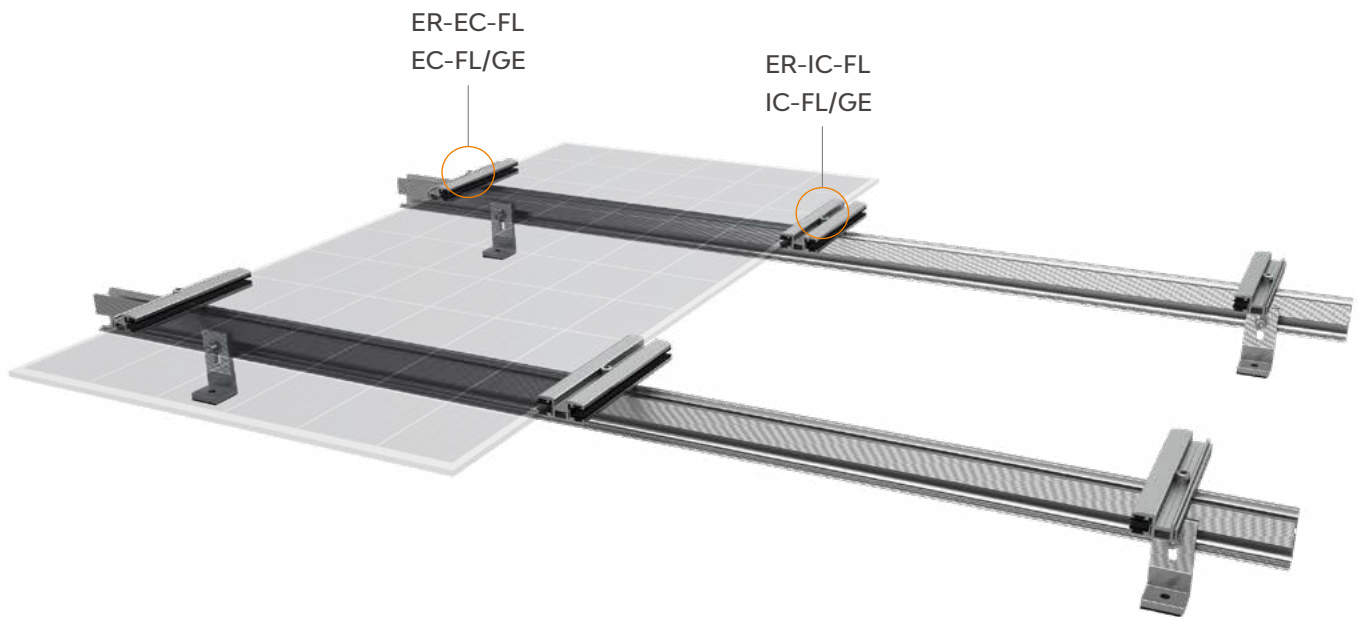

Clamps for frameless panels approved by



**10 Year
Warranty**

Commercial

Residential

Components



IC-FL/GE/6
IC-FL/GE/6/XX/B

Inter Clamp for 6mm Frameless Module (glued EPDM), Length 80mm, 120mm, 150mm

- Frameless Module (glued EPDM) Inter clamp-Upper part
- Frameless Module (glued EPDM) Inter clamp-Lower part
- Up Rubber Mat for Frameless module clamp (glued EPDM)
- Below Rubber Mat for Frameless module clamp (glued EPDM)
- Plain washer SUS304, 1mm
- Washer 8
- Hexagon socket head cap screw M8 x 30
- Z Module 2



EC-FL/GE/6
EC-FL/GE/6/XX/B

End Clamp for 6mm Frameless Module (glued EPDM), Length 80mm, 120mm, 150mm

- Frameless Module (glued EPDM) End clamp-Upper part
- Frameless Module (glued EPDM) End clamp-Lower part
- Up Rubber Mat for Frameless module clamp (glued EPDM)
- Below Rubber Mat for Frameless module clamp (glued EPDM)
- Plain washer SUS304, 1mm
- Washer 8
- Hexagon socket head cap screw M8 x 30
- Z Module 2

Available accessories

- Grounding/earthing
- Cable clips
- Cable Trays
- Rail caps

SolarTripod

Tilted flat roof frame designed for commercial installations

PV-ezRack® SolarTripod is designed for commercial PV-installations on flat roofs with tilted panels in portrait orientation. The supports are available in fix and adjustable tilt angles, in addition they are compatible with a wide range of purlin distances. The components are made entirely of structural grade (AL6005-T5) anodised aluminium and stainless steel. SolarTripod is available in two designs: single and double row panels.

Main Benefits

Quick Installation

Completely pre-assembled, the SolarTripod supports simply need to be unfolded and secured to the roof structure for installation. For most installations the legs require only 2 fixing points each and the rails can overcome large spans. All these features result in a fast, easy and cost efficient installation, crucial for commercial projects.

Maximising Installation Size and Output on Small Roofs

The DoubleTripod has two rows of PV-panels in portrait orientation.

This allows you to perfectly utilise narrow roof sections while doubling the installation size and output, where you would normally only be able to fit one row of panels.

Simplicity

Bill of materials can be confusing and complicated. On a basic BOM for SolarTripod you will only find 6 components, keeping it simple and transparent for all parties to better understand and work with the product.

**10 Year
Warranty**

Commercial

Residential

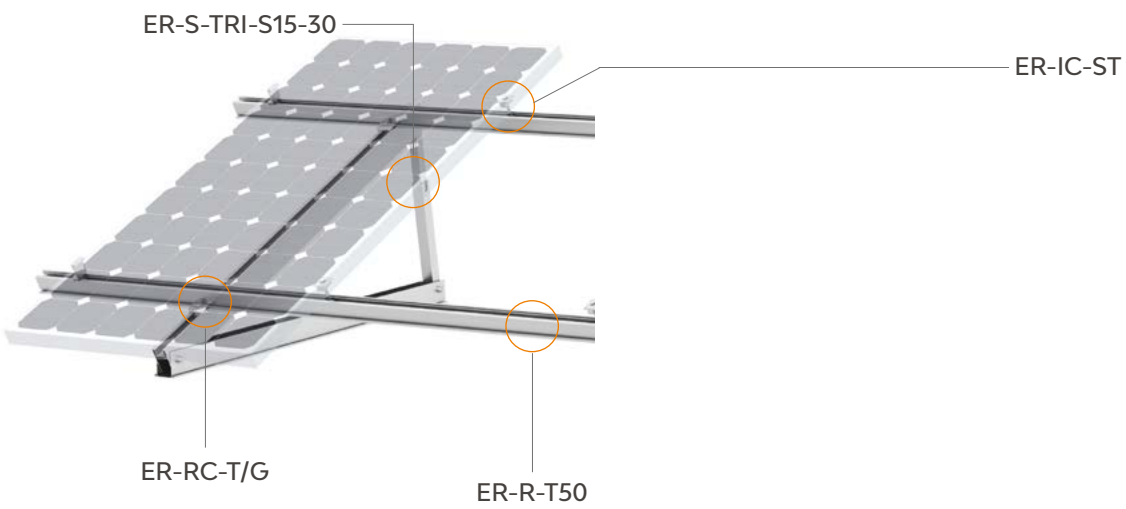
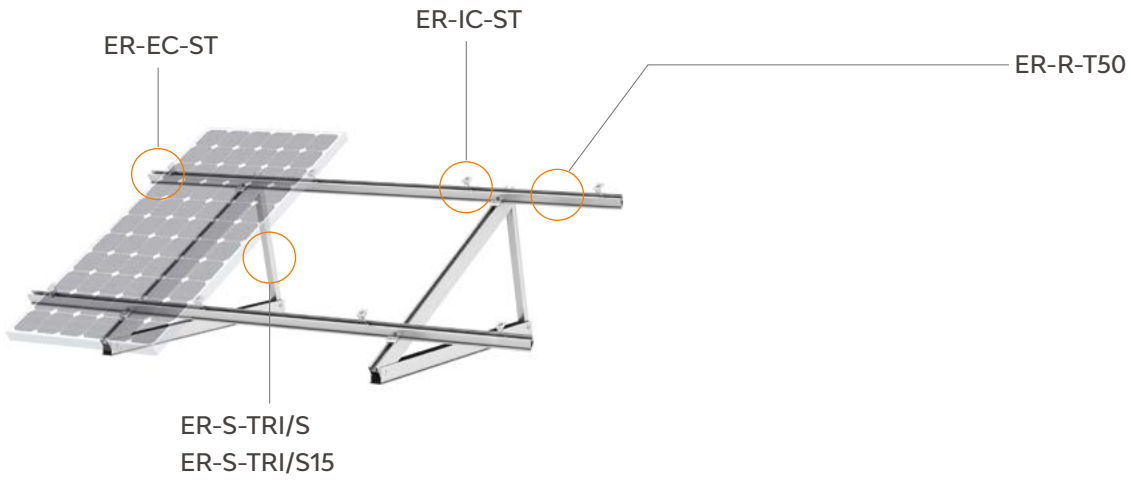

Available accessories

- Grounding/earthing
- Cable clips
- Cable Trays
- Rail caps

Components



ER-S-TRI/S30-AU

Solar Tripod, Single Support

- Hexagon socket head cap screw M10 x 65
- Plain washer 10
- Washer 10
- Hexagon nut M10
- Tripod U Bracket
- Tripod, Al-Tube 35.5 x 35.5 x 689
- Base Support 70 x 1350
- Upper Support 75 x 1250
- Bushing Ø18.5 x 35.5



ER-S-TRI30-D3000

Solar Tripod, Double Support

- Hexagon socket head cap screw M10 x 65
- Hexagon nut M10
- Plain washer 10
- Washer 10
- Tripod U Bracket
- Base Support 70 x 3000
- Upper Support 75 x 3000
- Tripod, Al-Tube 35.5 x 35.5 x 801
- Tripod, Al-Tube 35.5 x 35.5 x 1562
- Bushing Ø18.5 x 35.5



ER-S-TRI/S15-30

Adjustable Tripod

- Base Support 70 x 1350
- Upper Support 75 x 1250
- Leg Tube-358
- Leg Strug-348
- Bushing
- Double-Fixed Block(Anodized)
- Set screw M8 x 12
- Hexagon Socket bolt M10 x 65
- Hex nut M10
- Washer 10
- Flat washer 10
- U Bracket
- Bushing Ø18.5 x 35.5



ER-R-T50

T-Rail 50

- With standard lengths:
2560mm
3405mm
4200mm



ER-SP-T50

Splice for T-Rail 50

- Splice with standard length of 300mm
- Self-Tapping Screw ST6.3 x 22



ER-RC-T/G
Rail Clamp for T-Rail with
grounding/earthing pins

- Rail Clamp with pins 50 x 30 x 11.8mm
- Hex Socket Head Bolt M8 x 30mm
- Spring Washer M8
- Z-Module

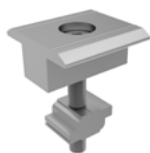

ER-IC-ST
Inter Clamp, Standard

- Inter Module Clamp 28mm, 35mm, 38mm, 40mm, 46mm, 50mm, 57mm
- 28mm with Hex Socket Head Bolt A2-70 M8 x 40mm
- 35mm with Hex Socket Head Bolt A2-70 M8 x 45mm
- 38mm with Hex Socket Head Bolt A2-70 M8 x 50mm
- 40mm with Hex Socket Head Bolt A2-70 M8 x 50mm
- 46mm with Hex Socket Head Bolt A2-70 M8 x 55mm
- 50mm with Hex Socket Head Bolt A2-70 M8 x 60mm
- 57mm with Hex Socket Head Bolt A2-70 M8 x 70mm
- Z-Module
- Washer 8



ER-EC-ST
End Clamp, Standard

- End Module Clamp 28mm, 32mm, 35mm, 38mm, 40mm, 42mm, 46mm, 48mm, 50mm
- Z-Module
- Hex Socket Head Bolt A2-70 M8 x 28
- Washer 8

SolarTripod Lite with Grounding Rail Clamp

Pre-assembled residential and commercial flat roof mounting system

The PV-ezRack® SolarTripod Lite with pre-assembled Supports, including pre-installed Rail Clamps, is an economical mounting system, which is suitable for residential and commercial flat roofs. It has one of the fastest installation speed in its class. This system is manufactured from structural grade aluminium alloy to ensure excellent corrosion resistance and light weight.

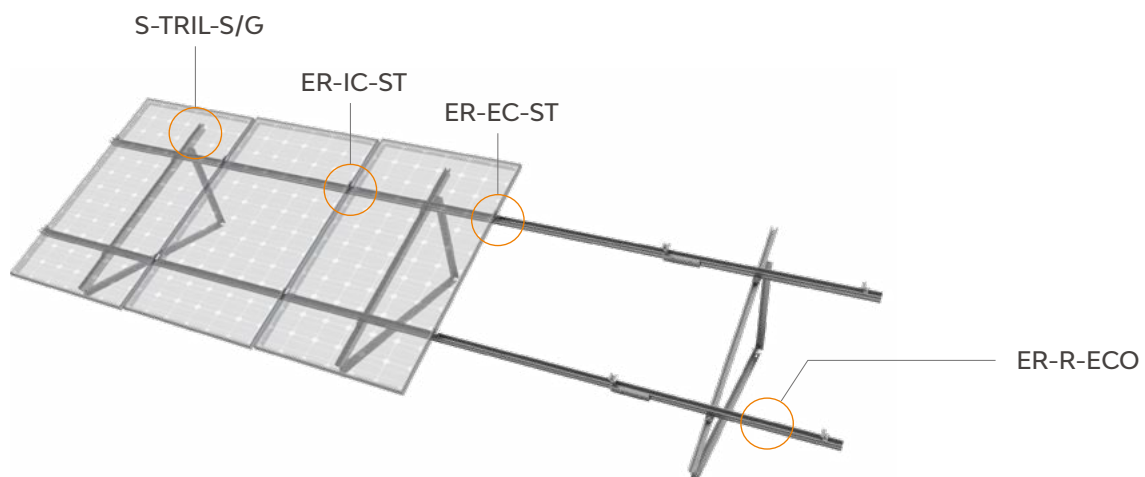

Main Benefits

Fast and Easy Installation

The Tripod supports are delivered with pre-set tilt angles, pre-assembled, which include the Rail Clamps pre-installed at the right position. This allows a quick and easy installation.

Cost Reduction

The combination of simple L-Shaped aluminium profiles with Z-Module channels in the support and the optimised ECO-Rail results in cost reduction without compromise in structural integrity.

Grounding/Earthing Function

The Rail clamps include the earthing pins, which provide continuity between rail and support. On the ECO-Rail the standard earthing clips and lugs can be used.

Universal Application

Standardised components are suitable for 60cell as well as for 72cell panels with the base length of 1350mm or 1700mm and with the tilt angle of 15° or 30°. Customised lengths and tilt angles are available on order.

**10 Year
Warranty**

Commercial

Residential

**Available
accessories**

■ **Grounding/earthing**

■ **Cable clips**

■ **Rail caps**

Components



S-TRIL-S/G
Support for SolarTripod single
Rail clamps pre-assembled

- Base support
- Upper support
- Base support 1350 / 1700
- Upper support 1500 / 1700
- Back support 15°
- Back support 30°
- Flat Bar 30x9 (Washer)
- Hexagonal Bolt M8 x 25
- Hexagonal Bolt M8 x 30
- Hexagon nut M8
- Washer 8
- Plain washer 8
- Grounding Rail Clamp for ECO-Rail
- Z-Module
- Hexagon socket head cap screw M8 x 30



ER-R-ECO
ECO-Rail

- With standard lengths 3600mm and 4400mm

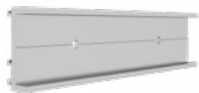

ER-SP-ECO
Splice for ECO-Rail

- Splice with a standard length of 200mm
- Hexagon socket head cap screw M8 x 12mm



ER-RC-T/G
Rail Clamp for T-Rail with
grounding/earthing pins

- Rail Clamp with pins 50x30x11.8mm
- Hex Socket Head Bolt M8x30mm
- Spring Washer M8
- Z-Module

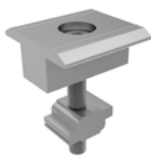

ER-IC-ST
Inter Clamp, Standard

- Inter Module Clamp 28mm, 35mm, 38mm, 40mm, 46mm, 50mm, 57mm
- 28mm with Hex Socket Head Bolt A2-70 M8 x 40mm
- 35mm with Hex Socket Head Bolt A2-70 M8 x 45mm
- 38mm with Hex Socket Head Bolt A2-70 M8 x 50mm
- 40mm with Hex Socket Head Bolt A2-70 M8 x 50mm
- 46mm with Hex Socket Head Bolt A2-70 M8 x 55mm
- 50mm with Hex Socket Head Bolt A2-70 M8 x 60mm
- 57mm with Hex Socket Head Bolt A2-70 M8 x 70mm
- Z-Module
- Washer 8



ER-EC-ST
End Clamp, Standard

- End Module Clamp 28mm, 32mm, 35mm, 38mm, 40mm, 42mm, 46mm, 48mm, 50mm
- Z-Module
- Hex Socket Head Bolt A2-70 M8 x 28
- Washer 8

SolarBase

Designed for Commercial Installations

Clenergy's low ballast roof system is specifically designed for installation of commercial roof photovoltaic systems. Highly-efficient design greatly simplifies installation, and optimal use of available space. Designed to be used as a non-penetrative, low-ballast mounting system can also be adapted to be positively fixed to roofs where required.

Main Benefits

Convenient Installation

The pre-assembled support leg with convenient and firm buckle design and simple bolt fixation saves installation time and cost for installers.

Advanced Design

The design of ballast and wind deflector effectively increases the stability of the photovoltaic system. The rubber pad underneath the support leg raises the whole system from the roof surface for water draining, helps to prevent corrosion and avoids damaging the roof membrane. The innovative curved structure design integrates elegance & strength. This efficient design not only reduces materials and cost but still guarantees system strength & durability.

Strict Quality Control

Clenergy conducts strict quality management and control of raw materials, purchasing and production process to guarantee structural integrity and service life of its manufactured systems.

Maximized Compatibility

Low-ballast, flat-roof system is compatible with most framed solar modules. The arrangement of arrays is very flexible, which maximizes power generation. Roof objects (air-con units, roof-lights, etc.) can be easily accommodated.

10 Year Warranty	Commercial	Available accessories	■ Grounding/earthing	■ Cable clips
	Residential			

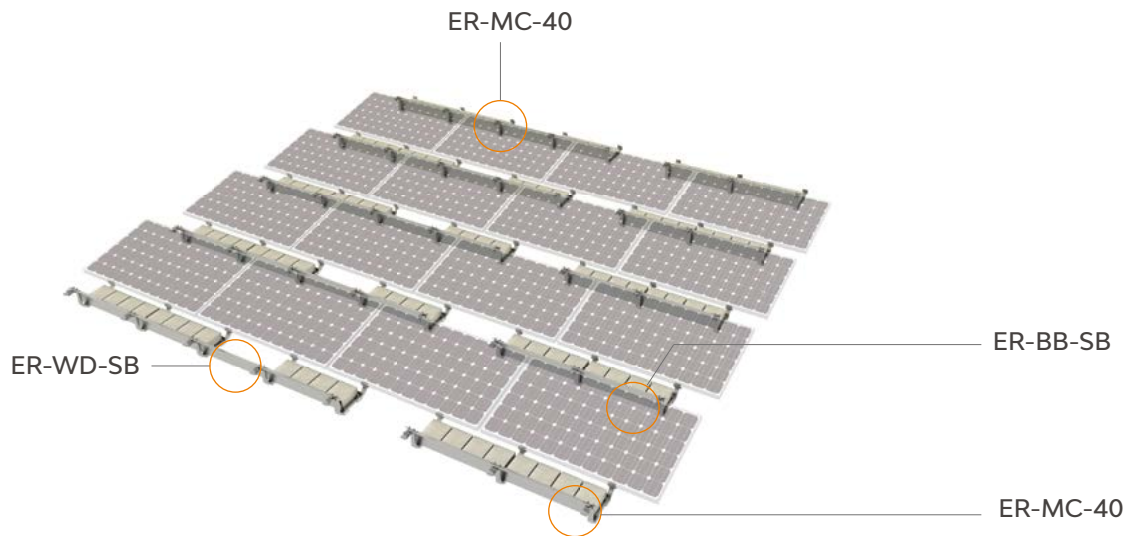

Components



ER-MC-40
Module Clamp (aluminum)

- PV-ezRack® Module Clamp 40 mm
- 40 Rim Clamp L35mm AL6005-T5
- Hexagon Socket bolt M8 x 25mm SUS304



ER-BB-SB
Ballast bar (galvanized steel)

- PV-ezRack® Ballast Bar for SolarBase, L900mm
- ballast Bar, L900 x 40 x T3.0mm Q235B
- Hexagon nut M8mm SUS304
- Washer 8mm SUS304
- Plain washer large 8 x 24mm SUS304



ER-WD-SB
Wind Deflector (2 options:
aluminium or galvanized steel)

- PV-ezRack® Wind Deflector for SolarBase, 10°
- Wind Deflectors 10 degree, 1700 x 195.8 x 263.6mm, aluminum AL/5052-H32
- U bolts M8 x 58mm Q235B
- Hexagon nut M8mm SUS304
- Washer 8mm SUS304
- Plain washer 8mm SUS304
- Fixing plate for Wind Deflectors, 120 x 38.1 x 3.5mm AL6005-T5



ER-S-SB/S
Support Leg (galvanized steel)

- PV-ezRack® Support Leg for SolarBase, 10°
- Support leg 579.9 x 40 x 269.6mm Q235
- Module Frame Front Mounting Clip 74.5 x 62 x 45mm AL6005-T5
- Hexagon socket head cap screw M8 x 75mm SUS304
- Hexagon nut M8mm SUS304
- Module Frame Back Mounting Clip 91 x 52 x 36.6mm AL6005-T5
- Hexagon socket head cap screw M8 x 35mm SUS304
- Washer 8mm SUS304
- Plain washer 8mm SUS304
- Cup head square neck bolts M8 x 45mm SUS304
- Bushing Ø18.5 x 20mm AL6005-T5
- O rubber rings Ø12 x 3mm EPDM

ComT

Tilt mounting system for PV Installation on commercial tin roof

The Clenergy PV-ezRack® Commercial Tilt is a universal and fast mounting system for PV installation on all common commercial tin roofs. With its flexible and scalable design it enables perfect utilization of roof surface available. With tilt angles of 5°, 10° or 15°, the PV panels can generate a maximum output.

Main Benefits

Easy and Quick Installation

Highly pre-assembled legs enable easy and fast installation. With our patented Z-Module, the legs can easily click into the slot of Rails at any given points.

Optimize Energy Output

The Legs can mount PV panels that width up to 1200 mm. And with 5° (available soon), 10° and 15° (available soon) tilt angles options, PV-ezRack® ComT can offer optimized energy output.

Three Optional Solutions

The solution using MT-Rail in conjunction with T-Rails and Legs is specially developed for tin roofs with a large purlin span over 3 m. And the other one using our popular L-feet, ECO-Rails and new Legs offers flexible height adjustable range. Both penetrative and non-penetrative solutions are available.

Universal

The adjustable clamps can mount framed PV panels that height from 30 to 46 mm. And with Clenergy various frameless clamps, PV-ezRack® Commercial Tilt can mount every size of frameless or thin film panels.

**10 Year
Warranty**

Commercial

Residential

Penetrative

< North - South Orientation >

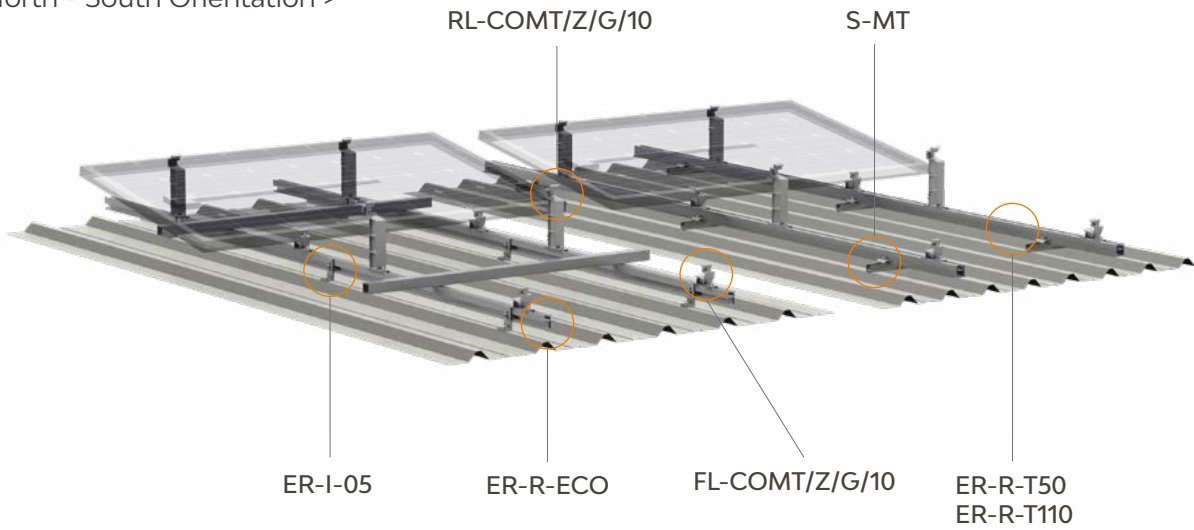

< East - West Orientation >



Non-Penetrative











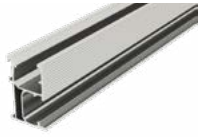

ER-I-09
ER-I-29/AU
ER-I-32/AU
ER-I-34

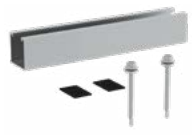
Available accessories

- Grounding/earthing
- Cable clips

Components

	<p>FL-COMT/Z/G/10 Front Leg Assembly, 10°, with Z-Module and Grounding Pins</p>	<ul style="list-style-type: none"> - ComT, front leg, 10°, with Grounding Pins - ComT, End Clamp - Washer 8 - Flat Washer 8 - Hexagon socket head cap screw M8 x 25 - Hexagon socket head cap screw M8 x 40 - spring 10.2 x 30 - Z Module (Anodized)
	<p>RL-COMT/Z/G/10 Rear Leg Assembly, 10°, with Z-Module and Grounding Pins</p>	<ul style="list-style-type: none"> - ComT, Rear leg, 10°, with Grounding Pins - ComT, End Clamp - Washer 8 - Flat Washer 8 - Hexagon socket head cap screw M8 x 25 - Hexagon socket head cap screw M8 x 40 - O rubber rings Ø10 x 1.9 - Z Module (Anodized)
	<p>ER-R-ECO ECO-Rail</p>	<ul style="list-style-type: none"> - Aluminium profile of ECO-Rail - With standard lengths 3600mm and 4400mm
	<p>ER-R-T110 ER-R-T110</p>	<ul style="list-style-type: none"> - T-Rail 110mm
	<p>ER-R-T50 T-Rail 50</p>	<ul style="list-style-type: none"> - With standard lengths 2560mm 3405mm 4200mm
	<p>S-MT/240 MT-Rail Support, 240mm</p>	<ul style="list-style-type: none"> - MT-Rail 240mm - Rubber Pad 40 x 25 x 2 - Buildex 14-11 x 70 Hex Head Zips screw
	<p>ER-I-05/CM Tin Interface with Click Module Assembly</p>	<ul style="list-style-type: none"> - Tin Roof Hook - Rubber Pad 38 x 38 x 2 - Main Click Module - Side Click Module - Washer 8 - Lock Washer M8 x 18 - Hexagon socket head cap screw M8 x 28 - Buildex 14-11 x 70 Hex Head Zips screw

	<p>ER-I-05 Tin Interface</p>	<ul style="list-style-type: none"> - Tin Roof Hook - Rubber Pad - Z-Module - Washer 8mm - Lock Washer 8mm A2 - Hex Socket Head Bolt M8 x 28mm - Buildex 14-11 x 70 Hex Head Zips screw
	<p>ER-RC-T/DM Rail Clamp for T-Rail, with Diamond Module</p>	<ul style="list-style-type: none"> - ezRack Rail Clamp for T-Rail - Diamond module M8 (for SolarMatrix) - Hexagon socket head cap screw M8 x 30 - Washer 8
	<p>ER-I-05A/EZC/ECO Tin Interface A with ezClick connection for ECO-Rail</p>	<ul style="list-style-type: none"> - Tin Roof Hook A - Rubber Pad 38 x 38 x 2 - Clamp 1 for ECO-Rail - Clamp 2 for ECO-Rail - ezClip Spring - Lock washer M8 x 18 - Hexagon socket head cap screw M8 x 28 - Buildex 14-11 x 70 Hex Head Zips screw
	<p>ER-I-25 Tin Interface with Curved Base for Corrugated Roof (Z Module + Bolt + Universal Screw)</p>	<ul style="list-style-type: none"> - L-shaped Corrugated Tin Feet Base - Rubber Pad 53 x 40 x 2 - Z Module (Anodized) - Washer 8 - Lock washer M8 x 18 - Hexagon socket head cap screw M8 x 28 - Buildex 14-11 x 70 Hex Head Zips screw

ComT 2.0

Tilt mounting system for PV installation on tin roof's

The Clenergy PV-ezRack® ComT 2.0 is an universal and fast mounting system for PV installation on all residential or commercial flat tin roofs. With its flexible and scalable design it enables perfect utilization of roof surface available. With tilt angles of 5°, 10° or 15°, the PV panels can generate a maximum output.

Main Benefits

Easy and Quick Installation

Highly pre-assembled legs enable easy and fast installation. With only one Z-Module, the legs can easily click into the slot of Rails at any given points. The storage space is greatly reduced due to the innovative 15° Rear Leg Extension, thereby saving the cost of warehouse management.

Optimize Energy Output

The Legs can mount PV panels that width up to 1200 mm. And with 5°, 10° and 15° tilt angles options, PV-ezRack® ComT 2.0 can offer optimized energy output.

Two Optional Solutions

The solution using MT-Rail in conjunction with T-Rails and Legs is specially developed for tin roofs with a large purlin span over 3 m. And the other one using our popular L-feet, ECO-Rails and new Legs offers flexible height adjustable range.

Universal

The adjustable clamps can mount framed PV panels that height from 30 to 46 mm. And with Clenergy various frameless clamps, PV-ezRack® ComT 2.0 can mount every size of frameless or thin film panels.

**10 Year
Warranty**

Commercial

Residential

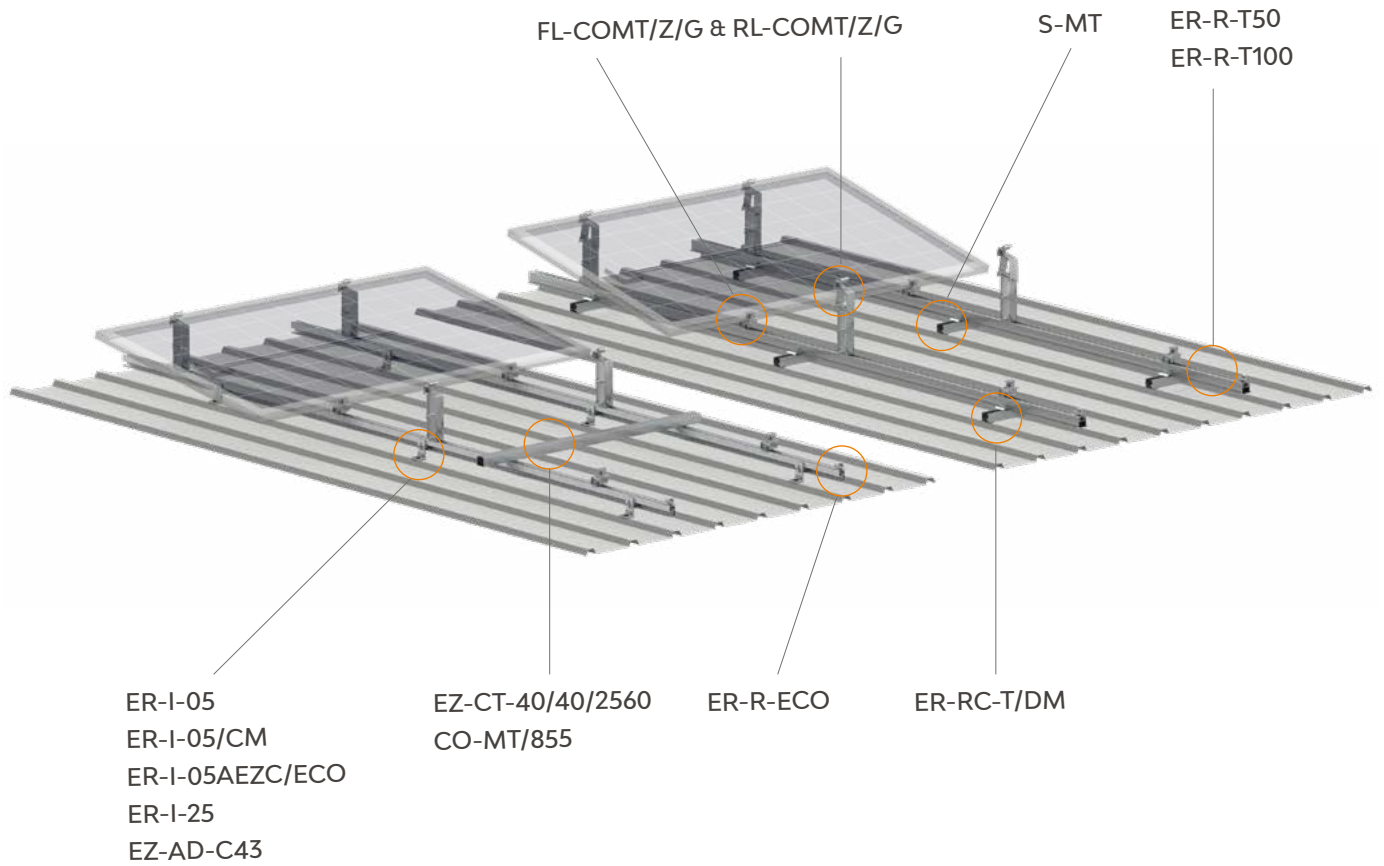









Available accessories

■ Grounding/earthing

■ Cable clips

Components

	<p>FL-COMT/Z/G/5 Front Leg Assembly, 5°, with Z-Module and Grounding Pins</p>	<ul style="list-style-type: none"> - ComT, front leg, 5°, with Grounding Pins - ComT, End Clamp - Washer 8 - Plain Washer 8 - Hexagon socket head cap screw M8 x 25 - Hexagon socket head cap screw M8 x 40 - Spring 10.2 x 30 - Z Module (Anodized)
	<p>RL-COMT/Z/G/5 Rear Leg Assembly, 5°, with Z-Module and Grounding Pins</p>	<ul style="list-style-type: none"> - ComT, Rear leg, 5°, with Grounding Pins - ComT, End Clamp - Washer 8 - Plain Washer 8 - Hexagon socket head cap screw M8 x 25 - Hexagon socket head cap screw M8 x 40 - O rubber rings Ø10 x 1.9 - Z Module (Anodized) - S1/4 x 200mm x H6
	<p>FL-COMT/Z/G/10V2 Front Leg Assembly, 10°, with Z-Module and Grounding Pins, version 2</p>	<ul style="list-style-type: none"> - ComT, front leg, 10°, with Grounding Pins, version 2 - ComT, End Clamp - Washer 8 - Plain Washer 8 - Hexagon socket head cap screw M8 x 25 - Hexagon socket head cap screw M8 x 40 - Spring 10.2 x 30 - Z Module (Anodized)
	<p>RL-COMT/Z/G/10V2 Rear Leg Assembly, 10°, with Z-Module and Grounding Pins, version 2</p>	<ul style="list-style-type: none"> - ComT, rear leg, 10 degree, with Grounding Pins, version 2 - ComT, End Clamp - Washer 8 - Plain Washer 8 - Hexagon socket head cap screw M8 x 25 - Hexagon socket head cap screw M8 x 40 - O rubber rings Ø10 x 1.9 - Z Module (Anodized) - S1/4 x 250mm x H6
	<p>FL-COMT/Z/G/15 Front Leg Assembly, 15°, with Z-Module and Grounding Pins</p>	<ul style="list-style-type: none"> - ComT, front leg, 15°, with Grounding Pins - ComT, End Clamp - Washer 8 - Plain Washer 8 - Hexagon socket head cap screw M8 x 25 - Hexagon socket head cap screw M8 x 40 - Spring 10.2 x 30 - Z Module (Anodized)
	<p>RL-E-COMT/G/15 Rear Leg Extender, 15°, with Grounding Pins</p>	<ul style="list-style-type: none"> - ComT, rear leg, 15 degree, with Grounding Pins - Washer 8 - External Teeth Lock Washer 8 - Hexagon socket head cap screw M8 x 16 - S1/4 x 330mm x H6

	<p>ER-R-ECO ECO-Rail</p>	<ul style="list-style-type: none"> - Aluminium profile of ECO-Rail - With standard lengths 3600mm and 4400mm
	<p>ER-R-T110 ER-R-T110</p>	<ul style="list-style-type: none"> - T-Rail 110mm
	<p>ER-R-T50 T-Rail 50</p>	<ul style="list-style-type: none"> - With standard lengths 2560mm 3405mm 4200mm
	<p>S-MT/240 MT-Rail Support, 240mm</p>	<ul style="list-style-type: none"> - MT-Rail 240mm - Rubber Pad 40 x 25 x 2 - Buildex 14-11 x 70 Hex Head Zips screw
	<p>ER-I-05/CM Tin Interface with Click Module Assembly</p>	<ul style="list-style-type: none"> - Tin Roof Hook - Rubber Pad 38 x 38 x 2 - Main Click Module - Side Click Module - Washer 8 - Lock Washer M8 x 18 - Hexagon socket head cap screw M8 x 28 - Buildex 14-11 x 70 Hex Head Zips screw
	<p>ER-I-05 Tin Interface</p>	<ul style="list-style-type: none"> - Tin Roof Hook - Rubber Pad - Z-Module - Washer 8mm - Lock Washer 8mm A2 - Hex Socket Head Bolt M8 x 28mm - Buildex 14-11 x 70 Hex Head Zips screw
	<p>ER-RC-T/DM Rail Clamp for T-Rail, with Diamond Module</p>	<ul style="list-style-type: none"> - ezRack Rail Clamp for T-Rail - Diamond module M8 (for SolarMatrix) - Hexagon socket head cap screw M8 x 30 - Washer 8
	<p>ER-I-05A/EZC/ECO Tin Interface A with ezClick connection for ECO-Rail</p>	<ul style="list-style-type: none"> - Tin Roof Hook A - Rubber Pad 38 x 38 x 2 - Clamp 1 for ECO-Rail - Clamp 2 for ECO-Rail - ezClip Spring - Lock washer M8 x 18 - Hexagon socket head cap screw M8 x 28 - Buildex 14-11 x 70 Hex Head Zips screw
	<p>ER-I-25 Tin Interface with Curved Base for Corrugated Roof (Z Module + Bolt + Universal Screw)</p>	<ul style="list-style-type: none"> - L-shaped Corrugated Tin Feet Base - Rubber Pad 53 x 40 x 2 - Z Module (Anodized) - Washer 8 - Lock washer M8 x 18 - Hexagon socket head cap screw M8 x 28 - Buildex 14-11 x 70 Hex Head Zips screw

SolarTerrace II-A

Pre-assembled, durable and earthed ground mount frame with ramming

PV-ezRack® SolarTerrace II-A is a pre-assembled ground mount system with full earthing function suitable for commercial and utility scale installations. This quality frame is trimmed at every angle for fast deployment reducing labour costs. It was designed with a unique post profile which allows reduced embedment and therefore saves on material and labour. These features, combined with its high grade of pre-assembly make SolarTerrace II-A one of the best ground mount system you can find.

Main Benefits

Reduced Labour Costs

Through our unique, patented component design and pre-assembled supports with pre-installed positioning clamps** labour time and costs are greatly reduced.

Reduced Component Costs

Our unique C-Post was designed specifically for ramming. This results in an increased friction against up-lift and it therefore requires less embedment as conventional standard posts or I-beams, which reduces not only labour time for ramming but also material costs.

Wide Range of Adjustments

As ramming can never be done exact on millimetre, the post head is designed with sufficient horizontal rotation and vertical adjustments. This combined with a generous design tolerance levels makes it easy to get the panels perfectly aligned even if the ramming isn't 100%.

Full Earthing Function

With pre-fitted pressure bolts and star washers in post head, post brace and pre-assembled support, it can create earthing continuity from T rail to post. In this way, SolarTerrace II-A system is a full earthing system.

10 Year
Warranty

Utility

Commercial

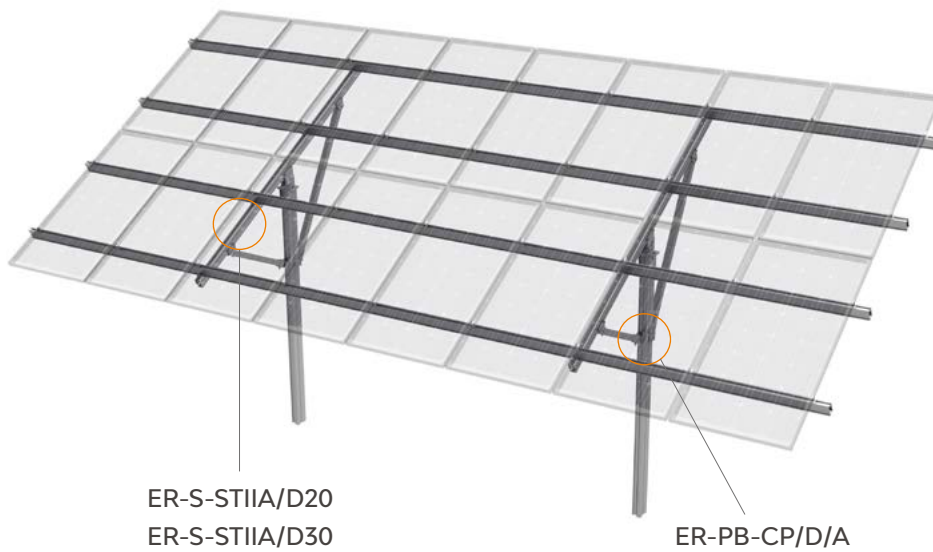
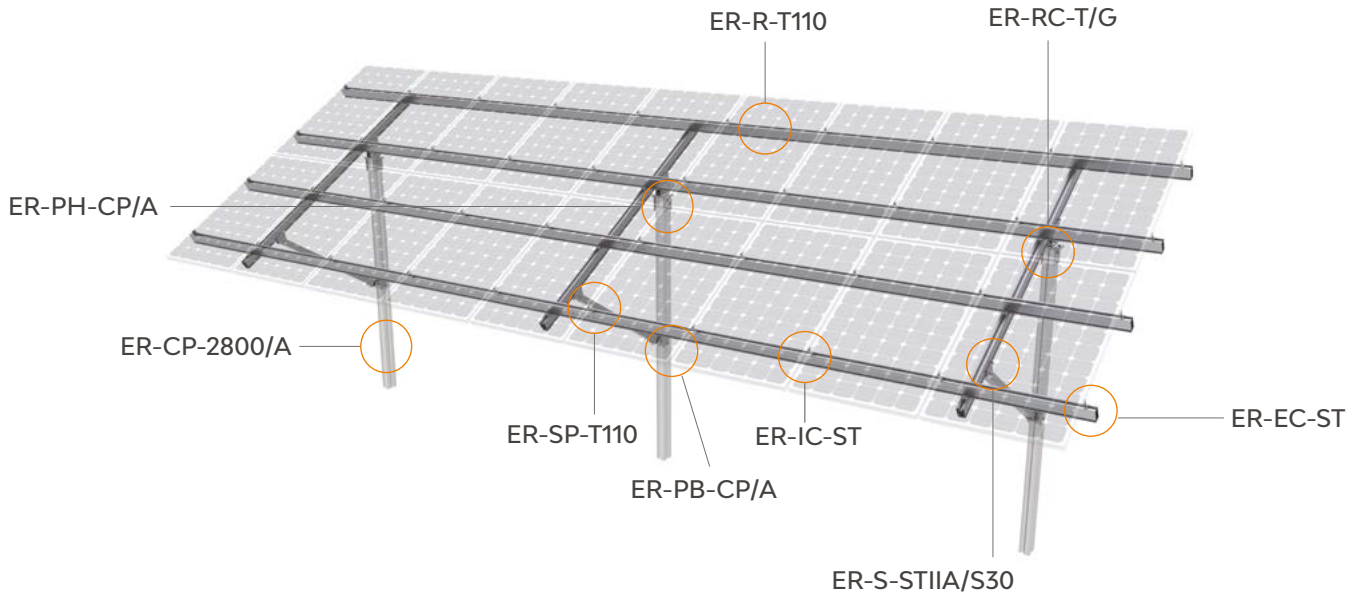

Available accessories

- Grounding/earthing
- Cable clips
- Cable trays
- Inverter/joint box bracket
- Rail and Girder cap

Components

	<p>ER-CP-2800/A C-Post 2800mm</p>	<ul style="list-style-type: none"> - Foundation C-Post L2800 x 140 x 95 mm
	<p>ER-R-T110 T-Rail 110</p>	<ul style="list-style-type: none"> - T-Rail 65 x 110mm - Standard Lengths 4200mm and 5200mm
	<p>ER-SP-T110 Splice for T-Rail 110</p>	<ul style="list-style-type: none"> - Splice 45.7 x 105.6mm - Flange Facing Self-Tapping Screw (washer) ST6.3 x 22
	<p>GE-STA/200 Girder Extension for SolarTerrace-A (II and III) 200mm</p>	<ul style="list-style-type: none"> - Splice for Tri-Groove Square Girder - Flange Facing Self-Tapping Screw (washer) ST6.3 x 22 - Alum profile of tri-groove Beam 200
	<p>ER-IC-ST Inter Clamp, Standard</p>	<ul style="list-style-type: none"> - Inter Module Clamp 28mm, 35mm, 38mm, 40mm, 46mm, 50mm, 57mm - 28mm with Hex Socket Head Bolt A2-70 M8 x 40mm - 35mm with Hex Socket Head Bolt A2-70 M8 x 45mm - 38mm with Hex Socket Head Bolt A2-70 M8 x 50mm - 40mm with Hex Socket Head Bolt A2-70 M8 x 50mm - 46mm with Hex Socket Head Bolt A2-70 M8 x 55mm - 50mm with Hex Socket Head Bolt A2-70 M8 x 60mm - 57mm with Hex Socket Head Bolt A2-70 M8 x 70mm - Z-Module - Washer 8
	<p>ER-EC-ST End Clamp, Standard</p>	<ul style="list-style-type: none"> - End Module Clamp 28mm, 32mm, 35mm, 38mm, 40mm, 42mm, 46mm, 48mm, 50mm - Z-Module - Hex Socket Head Bolt A2-70 M8 x 28 - Washer 8
	<p>ER-RC-T/G Rail Clamp for T-Rail with grounding/earthing pins</p>	<ul style="list-style-type: none"> - Rail Clamp with pins 50 x 30 x 11.8mm - Hex Socket Head Bolt M8 x 30 - Spring Washer M8 - Z-Module
	<p>ER-PH-CP/A Post Head for C-Post with Grounding</p>	<ul style="list-style-type: none"> - Clasp AL/6005-T5 - V-Spring - T-Head 142 x 166 x 126mm - T-Head Base 142 x 166 x 138.3mm - Hex Socket Head Bolt M12 x 35 - Hex Socket Head Bolt M12 x 130 - Flat Washer 12mm - Spring Washer 12mm - Hexagonal Nut - Rivet1 - External Teeth Lock Washer 12 - Set screw M8 x 12



ER-PB-CP/A

Post Brace for C-Post with Grounding

- Hinge Leaf
- Post Joint
- Rivet 2
- Hex Socket Head Bolt M12 x 55mm
- Hex Socket Head Bolt M12 x 100mm
- Spring Washer 12mm
- Flat Washer 12
- Hexagonal Nut M12
- External Teeth Lock Washer 12
- Set screw M8 x 12



ER-PB-CP/D/A

Post Brace for C-Post on Double Support with Grounding

- Post Joint with Grounding Hole
- Hinge Leaf
- Rivet2
- Hexagonal Bolt M12 x 55
- Hexagonal bolt M12 x 100
- Hexagon nut M12
- Washer 12
- Plain washer 12
- External Teeth Lock Washer 12
- Set screw M8 x 12



BR-R110/EW/G

PV-ezRack East/West Adjustable Bracket for T-Rail 110 with grounding

- East/West adjustable bracket with Grounding Hole-top
- Bushing Ø18.5 x 9
- East/West adjustable bracket-bottom
- Hexagon socket head cap screw M8 x 25
- Washer 8
- Z Module
- Hexagonal Bolt M12x50
- Washer 12
- External Teeth Lock Washer 12
- Hexagon nut M12
- Corragated shim (t6) with Ø8.5 hole
- Hexagon socket head cap screw M8 x 30
- O rubber rings Ø12 x 3
- Grounding Clip, with clenergy logo
- Grounding Rail Clamp for T Rail



ER-S-STIIA/S30; 2800mm girder

- Tri Groove Beam 2800mm
- H-Joint
- Hex Socket Head Bolt M12 x 100
- Hex Socket Head Bolt M12 x 110
- Spring Washer 12mm
- Spring Washer 8mm
- Joint Shoe with grounding hole L60 x 73 x 114mm
- T Slide Clamp
- Tube Support/S
- Plain Washer 8mm
- Plain Washer 12mm
- Hexagonal Nut M12
- Hexagonal Nut M8
- Corrugated H-Joint
- Corrugated Shim
- Hexagon socket head cap screw M8 x 25
- Hexagon socket head cap screw M8 x 40
- External Teeth Lock Washer 8
- External Teeth Lock Washer 12
- Set screw M8 x 12



**ER-S-STIIA/D20; 3200mm girder
ER-S-STIIA/D30; 3200mm girder**

- Tri Groove Beam 3200mm
- H-Joint
- Hex Socket Head Bolt M12 x 100
- Hex Socket Head Bolt M12 x 110
- Spring Washer 12mm
- Spring Washer 8mm
- Joint Shoe with grounding hole L60 x 73 x 114mm
- T Slide Clamp
- Tube Support/D
- Plain Washer 8mm
- Plain Washer 12mm
- Hexagonal Nut M12
- Hexagonal Nut M8
- Corrugated H-Joint
- Corrugated Shim
- Hexagon socket head cap screw M8 x 25
- Hexagon socket head cap screw M8 x 40
- External Teeth Lock Washer 8
- External Teeth Lock Washer 12
- Set screw M8 x 12

SolarTerrace III-A

Universal and earthed ground mount frame for corrosive environments and for tough soil conditions

Manufactured from high quality structural grade and anodised aluminium, PV-ezRack® SolarTerrace III-A is the perfect mounting solution for corrosive environments. The support legs can be installed either with concrete ballast footing or on ground screws which makes it suitable for almost every soil condition. Its user friendly high level of prefabrication makes it easy to install and therefore practical for smaller commercial and even for residential installations.

Main Benefits

Durable Even in Harsh Environments

STIII-A contains only 6005 Aluminium alloy and 304 stainless steel (316 on request), which makes it suitable for even the toughest environments, such as corrosive sites close to coastlines.

Support Leg Is Delivered in One Piece

The support legs of the STIII-A are completely pre-assembled, they only needed to be opened up and secured to the foundation. They even have the positioning rail clamps pre-installed**, so you don't need to measure and mark the rail positions anymore. The combination of these features is saving valuable time in assembly and logistics, making it one of the fastest system on the market.

Suitable for All Soil and Ground Type

The support legs can be installed either with a concrete ballast footing or with ground screws. This makes STIII-A suitable for the most challenging soil conditions where ramming is not possible.

Full Earthing Function

With pre-fitted pressure bolts and star washers in the pre-assembled support, it can create earthing continuity from T-Rail to support. In this way, SolarTerrace III-A system is a full earthing system.

**10 Year
Warranty**

Commercial

Utility

Residential

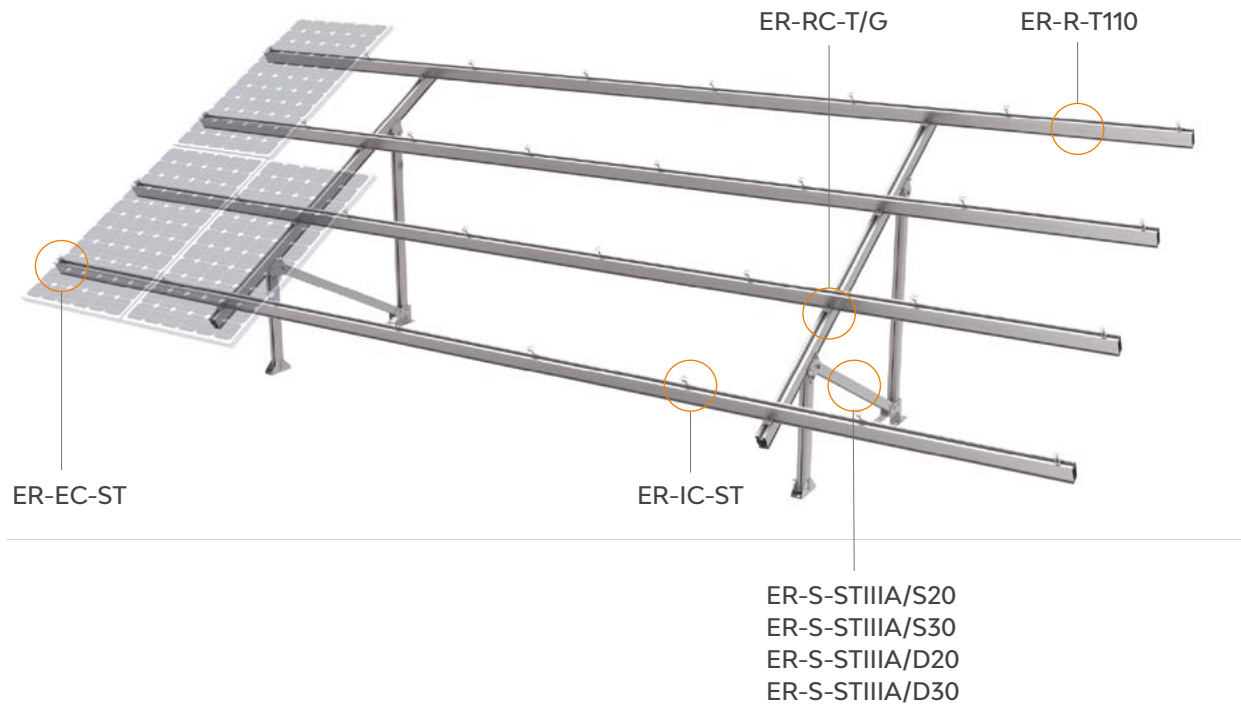

Available accessories

- Grounding/earthing
- Cable clips
- Cable trays
- Inverter/joint box bracket
- Rail and Girder cap

Components



ER-R-T110
T-Rail 110mm

- T-Rail 65 x 110mm
- Length from 2000mm to 6100mm
- Standard Lengths 4200mm and 5200mm



ER-SP-T110
Splice for T-Rail 110

- Splice 45.7 x 105.6mm
- Flange Face Self-Tapping Screw
- Self tapping screw M6.3 x 22



GE-STA/200
Girder Extension for SolarTerrace-A
(II and III) 200mm

- Splice for Tri-Groove Square Girder
- Flange Facing Self-Tapping Screw (washer) ST6.3 x 22
- Alum profile of tri-groove Beam 200



ER-RC-T/G
Rail Clamp for T-Rail with
grounding/earthing pins

- Rail Clamp with pins 50 x 30 x 11.8mm
- Hex Socket Head Bolt M8 x 30
- Spring Washer M8
- Z-Module

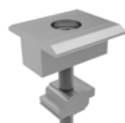

ER-IC-ST
Inter Clamp, Standard

- Inter Module Clamp 28mm, 35mm, 38mm, 40mm, 46mm, 50mm, 57mm
- 28mm with Hex Socket Head Bolt A2-70 M8 x 40mm
- 35mm with Hex Socket Head Bolt A2-70 M8 x 45mm
- 38mm with Hex Socket Head Bolt A2-70 M8 x 50mm
- 40mm with Hex Socket Head Bolt A2-70 M8 x 50mm
- 46mm with Hex Socket Head Bolt A2-70 M8 x 55mm
- 50mm with Hex Socket Head Bolt A2-70 M8 x 60mm
- 57mm with Hex Socket Head Bolt A2-70 M8 x 70mm
- Z-Module
- Washer 8



ER-EC-ST
End Clamp, Standard

- End Module Clamp 28mm, 32mm, 35mm, 38mm, 40mm, 42mm, 46mm, 48mm, 50mm
- Z-Module
- Hex Socket Head Bolt A2-70 M8 x 28
- Washer 8



ER-S-STIIIA/S20; 2800mm girder
ER-S-STIIIA/S30; 2800mm girde

SolarTerrace III-A Support
 (pre-assembled)

- STIIIA-A, Slotted Al-Tubes 60×60×L with Grounding Hole
- H Joint L135.6×74.5 x 119
- 0° H Joint L140×74.5 x 119
- Corrugated U-anchor Plate with Grounding Hole L180 x 73.5 x 100
- Corrugated L-anchor Plate L180 x 55 x 100
- Alum Profile of tri-groove Beam 2800mm
- Hexagon socket head cap screw M8 x 25
- Plain washer 8
- Hexagon socket head cap screw M8 x 40
- Hexagon nut M8
- External Teeth Lock Washer 8
- Washer 8
- T slide clamp
- Hexagonal bolt M12 x 100
- Hexagonal bolt M12 x 110
- Set screw M8 x 12
- External Teeth Lock Washer 12
- Hexagon nut M12
- Washer 12
- Plain washer 12



BR-R110/EW/G
 PV-ezRack East/West Adjustable
 Bracket for T-Rail 110 with grounding

- East/West adjustable bracket with Grounding Hole-top
- Bushing Ø18.5 x 9
- East/West adjustable bracket-bottom
- Hexagon socket head cap screw M8 x 25
- Washer 8
- Z Module
- Hexagonal Bolt M12 x 50
- Washer 12
- External Teeth Lock Washer 12
- Hexagon nut M12
- Corragated shim (t6) with Ø8.5 hole
- Hexagon socket head cap screw M8 x 30
- O rubber rings Ø12 x 3
- Grounding Clip, with clenergy logo
- Grounding Rail Clamp for T Rail



ER-S-STIIIA/D20; 3200mm girder
ER-S-STIIIA/D30; 3200mm girder

SolarTerrace III-A Support
 (pre-assembled)

- STIIIA-A, Slotted Al-Tubes 60×60×L with Grounding Hole
- H Joint L135.6 x 74.5 x 119
- 0° H Joint L140 x 74.5 x 119
- Corrugated U-anchor Plate with Grounding Hole L180 x 73.5 x 100
- Corrugated L-anchor Plate L180 x 55 x 100
- Alum profile of tri-groove Beam 3200mm
- Hexagon socket head cap screw M8 x 25
- Plain washer 8
- Hexagon socket head cap screw M8 x 40
- Hexagon nut M8
- External Teeth Lock Washer 8
- Washer 8
- T slide clamp
- Hexagonal bolt M12 x 100
- Hexagonal bolt M12 x 110
- Set screw M8 x 12
- External Teeth Lock Washer 12
- Hexagon nut M12
- Washer 12
- Plain washer 12

SolarTerrace V

Utility scale ground mount frame with time saving smart design

PV-ezRack® SolarTerrace V is developed for utility scale PV-deployments with panels in landscape orientation. The system offers a wide range of adjustability, easy deployment and enables the implementation of large arrays. STV is a simple and robust structure so it can be installed even with untrained labour forces. All these features result in fast, easy and cost efficient installation. Main aluminium components have a standard 10µm anodisation.

Main Benefits

Post-head Adjustability

The smart design of the Post head provides adjustments in all directions to balance out inaccuracies which often occur through the nature of the ramming process. These generous adjustments allow easier and quicker installation.

Easy Deployment

The connection between the main beams (Clipped T-rail 160) and the Post head is using special, spring supported rail clamps which easily slide and clip on to the bottom of the rail eliminating the often used and time consuming nut and bolt connection.

Utility Optimised Large Arrays

STV is designed for utility scale applications and therefore offers large arrays, huge horizontal spans combined with up to 6 landscape panels (72 cells) in one row. Furthermore the design allows the panel rows to be pre-assembled to the rails off-site in controlled environment. All this saves valuable installation time on-site and increases efficiency during installation.

Simplicity

Sometimes bill of materials can be confusing and complicated. Not with Clenergy, on a basic BOM for STV you will only find 8 components. Keeping it simple and transparent helps all parties to understand and work with the product better.

10 Year
Warranty

Commercial



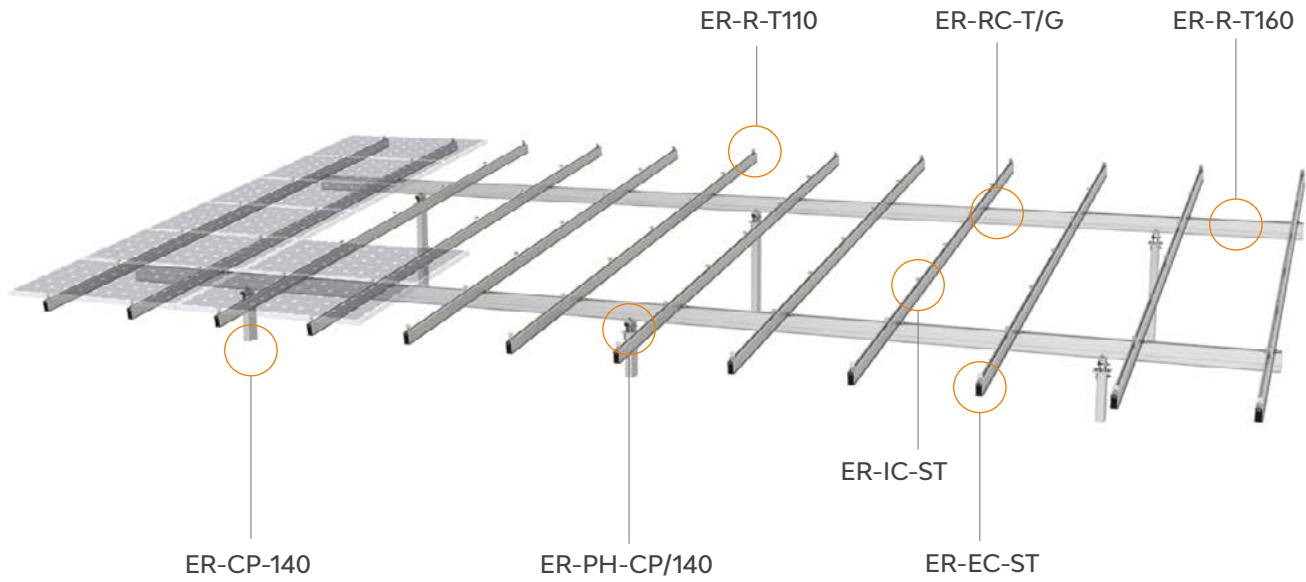

Residential



Available accessories

- Grounding/earthing
- Cable clips
- Cable trays
- Inverter/joint box bracket
- Rail and Girder cap

Components

	<p>ER-R-T160 Clipped T-Rail 160</p>	<ul style="list-style-type: none"> - Clipped T-Rail 92 x 160mm - Length up to 6100mm
	<p>ER-SP-T160 Splice for Clipped T-Rail 160</p>	<ul style="list-style-type: none"> - Splice for Clipped T-Rail 160 - Flange Face Self-Tapping Screw (with washer) ST6.3 x 22mm
	<p>ER-CP-140 C-Post 140</p>	<ul style="list-style-type: none"> - C-Post 70 x 140mm
	<p>ER-PH-CP/140 Post Head for C post 140</p>	<ul style="list-style-type: none"> - Mounting Base for Clipped T-160 Rail - Rail clamp for Clipped T-160 Rail - Snap-head bolt M8 x 40 - Hexagon nut with flange M8 - Washer M8.5 x 20 - ezClip Spring - Corragated shim - Washer 12mm - Plain washer 12mm - Hexagon nut M12 - Bushing Ø18.5 x 35.5mm - Upper T-Head - Hexagonal bolt M12 x 25 - Lower T-Head - Hexagonal bolt M12 x 110
	<p>ER-PH-CP/140/EW Post Head for C post 140/EW</p>	<ul style="list-style-type: none"> - Mounting Base for Clipped T-160 Rail - Rail clamp for Clipped T-160 Rail - Snap-head bolt M8 x 40 - Hexagon nut with flange M8 - Washer M8.5 x 20 - ezClip Spring - Corragated shim - Washer 12mm - Plain washer 12mm - Hexagon nut M12 - Bushing Ø18.5 x 35.5mm - Upper T-Head - Hexagonal bolt M12 x 25 - Lower T-Head - Hexagonal bolt M12 x 110



ER-R-T110
T-Rail 110mm

- T-Rail 65 x 110mm
- Length from 2000mm to 6100mm
- Standard Lengths 4200mm and 5200mm



ER-RC-T/G
Rail Clamp for T-Rail with
grounding/earthing pins

- Rail Clamp with pins 50x30x11.8mm
- Hex Socket Head Bolt M8x30
- Spring Washer M8
- Z-Module

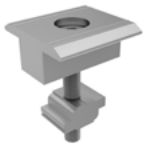

ER-IC-ST
Inter Clamp, Standard

- Inter Module Clamp 28mm, 35mm, 38mm, 40mm, 46mm, 50mm, 57mm
- 28mm with Hex Socket Head Bolt A2-70 M8 x 40mm
- 35mm with Hex Socket Head Bolt A2-70 M8 x 45mm
- 38mm with Hex Socket Head Bolt A2-70 M8 x 50mm
- 40mm with Hex Socket Head Bolt A2-70 M8 x 50mm
- 46mm with Hex Socket Head Bolt A2-70 M8 x 55mm
- 50mm with Hex Socket Head Bolt A2-70 M8 x 60mm
- 57mm with Hex Socket Head Bolt A2-70 M8 x 70mm
- Z-Module
- Washer 8



ER-EC-ST
End Clamp, Standard

- End Module Clamp 28mm, 32mm, 35mm, 38mm, 40mm, 42mm, 46mm, 48mm, 50mm
- Z-Module
- Hex Socket Head Bolt A2-70 M8 x 28
- Washer 8

PostMount 1-A, 2-A, 3-A and 4-A

Robust pole mount system with adjustable angle for one, two, three and four panels

PV-ezRack® PostMount-A delivers flexible and durable designs to mount from one to four panels per post. It's ideal for remote off-grid applications such as water pumps or small residential and commercial systems. The panel tilt is easily adjustable between 10° and 60° throughout the year and comes with hassle-free mounting thanks to patented components such as the PV-ezRack® rails and clamps. The combination of high quality aluminium, stainless steel and galvanised steel components make this a robust, reliable system with excellent corrosion resistance.

Main Benefits

Suitable for Every Soil Condition

With its concrete foundation, PostMount can be installed on even or uneven ground or on a slope, making it suitable for any soil type and a wide range of applications.

Adjustable Tilt Angle

The steel cap (post head) is designed to tilt panels between 10° and 60° to ensure that you get the required power output you need – anywhere, anytime. Changing the angle merely requires a single pair of spanners.

Robust and Reliable

Mounted on aluminium rails the panels are supported by robust galvanised steel landscape and master tubes secured with stainless steel bolts. The post can be fixed into a concrete foundation and also used as a ramming option.

Quick and Easy Installation

Innovative and internationally patented, the Z-Module technology is used in almost all PV-ezRack® components. The Z-Module provides a quick, easy and safe installation method and can be inserted into the rail at any given point, secured with just three hand grips.

**10 Year
Warranty**

Commercial

Residential

PM1-A

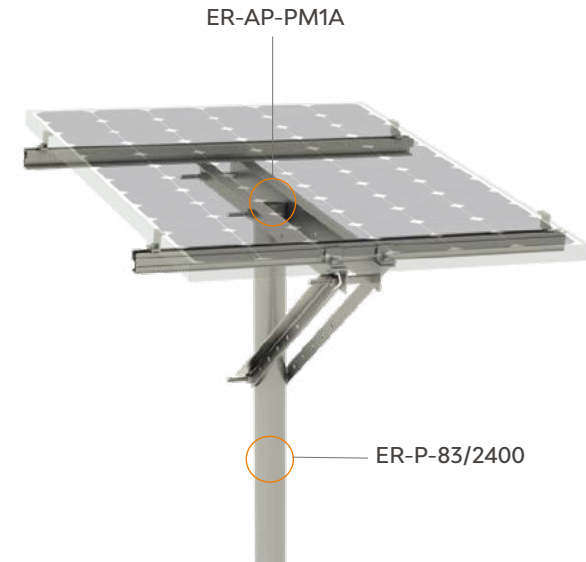

PM2-A

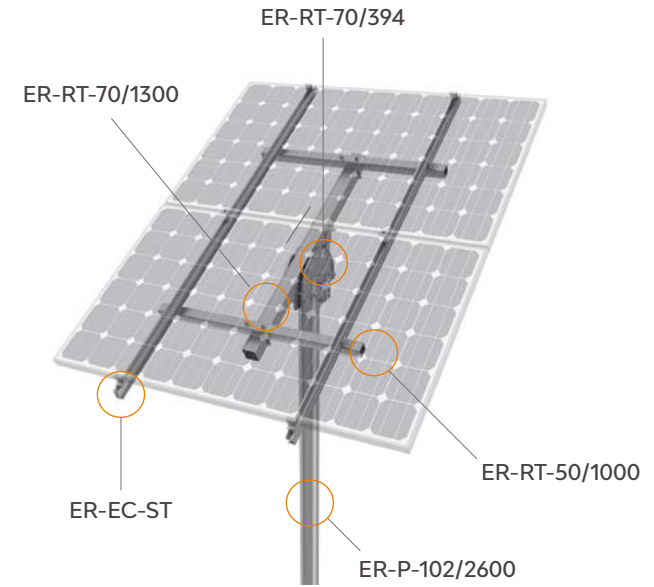

PM3-A

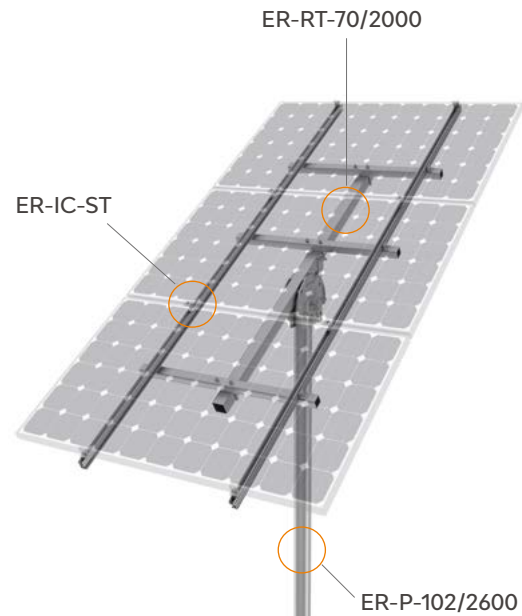



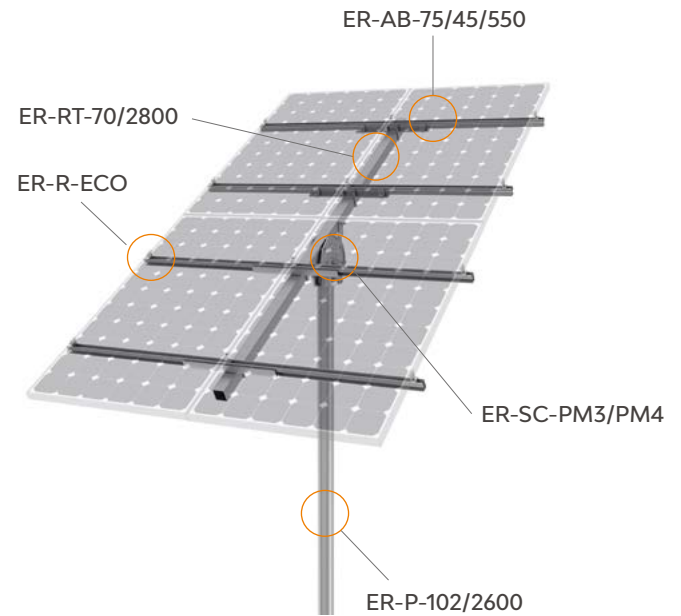



PM4-A



Available accessories

- Grounding/earthing
- Cable clips
- Rail and Girder cap

Components

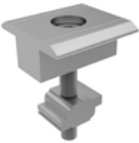
	<p>ER-P-102/2600 ER-P-83/2400</p> <p>Pipe Diameter</p>	<ul style="list-style-type: none"> - Pipe Diameter Ø102 x 2600 (PM2, 3, 4-A Pole) - Pipe Diameter Ø83 x 2400 (PM1-A Pole)
	<p>ER-RT-50/1000</p> <p>Rectangular Tube</p>	<ul style="list-style-type: none"> - Rectangular Tube-Landscape 50 x 50 x 1000
	<p>ER-R-ECO</p> <p>ECO-Rail</p>	<ul style="list-style-type: none"> - Aluminium profile of ECO-Rail - With standard lengths 3600mm and 4400mm
	<p>ER-RT-70/394</p> <p>Adjustable Tube 70 x 50 x 394</p>	<ul style="list-style-type: none"> - Adjustable Tube 70 x 50 x 394 - Hexagonal bolt M14 x 120 - Hexagon nut M14 - Plain washer 14 - Washer 14
	<p>ER-RT-70/1300 ER-RT-70/2000 ER-RT-70/2800</p> <p>Rectangular Tube 70 x 70 x L</p>	<ul style="list-style-type: none"> - Rectangular Tube 70 x 70 x L
	<p>ER-EC-ST</p> <p>End Clamp, Standard</p>	<ul style="list-style-type: none"> - End Module Clamp 28mm, 32mm, 35mm, 38mm, 40mm, 42mm, 46mm, 48mm, 50mm - Z-Module - Hex Socket Head Bolt A2-70 M8 x 28 - Washer 8
	<p>ER-IC-ST</p> <p>Inter Clamp, Standard</p>	<ul style="list-style-type: none"> - Inter Module Clamp 28mm, 35mm, 38mm, 40mm, 46mm, 50mm, 57mm - 28mm with Hex Socket Head Bolt A2-70 M8 x 40mm - 35mm with Hex Socket Head Bolt A2-70 M8 x 45mm - 38mm with Hex Socket Head Bolt A2-70 M8 x 50mm - 40mm with Hex Socket Head Bolt A2-70 M8 x 50mm - 46mm with Hex Socket Head Bolt A2-70 M8 x 55mm - 50mm with Hex Socket Head Bolt A2-70 M8 x 60mm - 57mm with Hex Socket Head Bolt A2-70 M8 x 70mm - Z-Module - Washer 8



ER-AB-75/45/550

Angle Bracket 75 x 45 x 550

- Postmount4-A Angle Bracket 75 x 45 x 550
- U bolt for Tube110
- Plain washer 10
- Washer 10
- Hexagon nut M10
- Hexagon socket head cap screw M8 x 28
- Plain washer 8
- Washer 8
- Hexagon nut M8
- Cross connection clamp



SC-PM2/3/4A

Steel Cap Assembly

- Steel Cap of PM3-A, PM4-A
- Square washer for PM3-A, PM4-A
- Hexagonal bolt M14 x 150
- Hexagonal bolt M14 x 110
- Plain washer 14
- Washer 14
- Hexagon nut M14
- U washer T1.0 (for PM-A system)
- U washer T2.0 (for PM-A system)



ER-AP-PM1A

PV-ezRack® PM1-A,
Accessory Package

- Aluminum Profile Of ECO-rail 1100, L1100mm
- Angle Steel 63 x 40 x 1010 x T4mm
- Angle Steel 40 x 40 x 682 x T4mm, Right Supporting Rod
- Angle Steel 40 x 40 x 682 x T4mm, Left Supporting Rod
- Sleeve $\varnothing 20 \times 83 \times T3$ mm
- Cross Connection Clamp of ECO-rail, L40mm
- Cup Head Square Neck Bolts M8 x 25
- Hexagon Nut With Flange M8
- Hexagonal Bolt S M12 x 120
- Plain Washer 12mm
- Washer 12mm
- Hexagon Nut M12
- End Clamp 40mm
- Hexagon Socket Head Cap Screw M8 x 28
- Washer 8
- Z module, L20mm

PostMount 6-A and 8-A

Robust pole mount system with adjustable angle for six and eight panels

PV-ezRack® PostMount-A delivers flexible and durable designs to mount six or eight panels per post. It is ideal for remote off-grid applications such as water pumps or small residential and commercial systems. The panel tilt is easily adjustable between 10° and 60° throughout the year and comes with hassle-free mounting thanks to patented components such as the PV-ezRack® rails and clamps. The combination of high quality aluminium, stainless steel and galvanised steel components make this a robust, reliable system with excellent corrosion resistance.

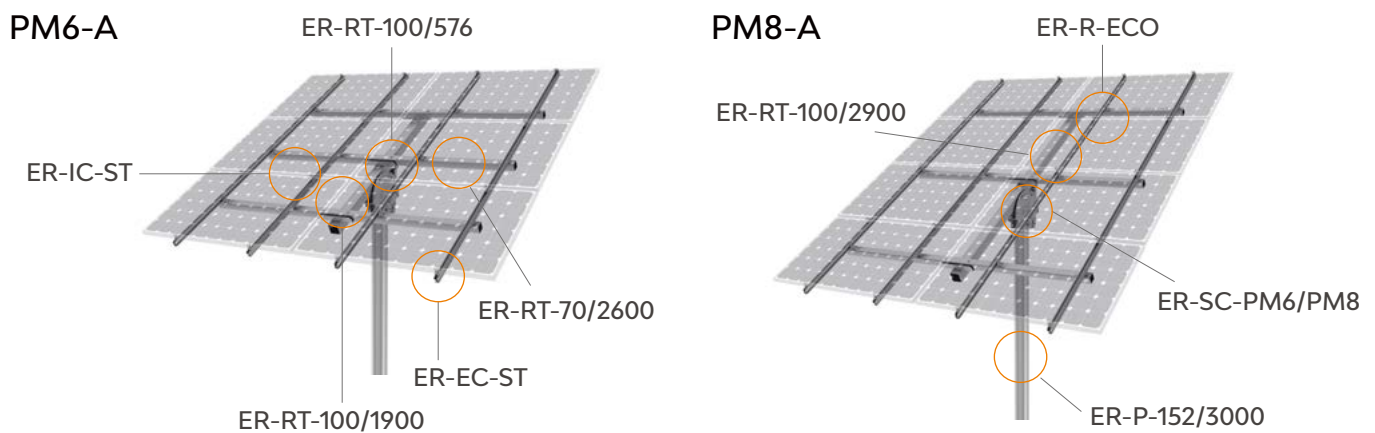

Main Benefits

Suitable for Every Soil Condition

With its concrete foundation, PostMount can be installed on even or uneven ground or on a slope, making it suitable for any soil type and a wide range of applications.

Adjustable Tilt Angle

The steel cap (post head) is designed to tilt panels between 10° and 60° to ensure that you get the required power output you need – anywhere, anytime. Changing the angle merely requires a single pair of spanners.

Robust and Reliable

Mounted on aluminium rails the panels are supported by robust galvanised steel landscape and master tubes secured with stainless steel bolts. The post can be fixed into a concrete foundation and also used as a ramming option.

Quick and Easy Installation

Innovative and internationally patented, the Z-Module technology is used in almost all PV-ezRack® components. The Z-Module provides a quick, easy and safe installation method and can be inserted in to the rail at any given point, secured with just three hand grips.

**10 Year
Warranty**









Commercial

Residential

**Available
accessories**

■ Grounding/earthing ■ Cable clips ■ Rail and Girder cap

Components

	<p>ER-P-152/3000 Pipe 152 x 3000 (PM6,8-A Pole)</p>	<ul style="list-style-type: none"> - Pipe Diamete Ø 152 x 3000
	<p>ER-R-ECO ECO-Rail</p>	<ul style="list-style-type: none"> - Aluminium profile of ECO-Rail - With standard lengths 3600mm and 4400mm
	<p>ER-RT-100/576 Adjustable Tube 100 x 50 x 576</p>	<ul style="list-style-type: none"> - Adjustable Tube 100 x 50 x 576 - Hexagonal bolt M20 x 160 - Hexagon nut M20 - Plain washer 20 - Washer 20
	<p>ER-RT-100/1900 ER-RT-100/2900 Rectangular Tube 100x100xL</p>	<ul style="list-style-type: none"> - Rectangular tube 100 x 100 x L with pre-welded angle brackets
	<p>ER-RT-70/2600 Rectangular Tube</p>	<ul style="list-style-type: none"> - Rectangular Tube-Landscape 70 x 70 x 2600
	<p>ER-SC-PM6/PM8 Steel Cap Assembly</p>	<ul style="list-style-type: none"> - Steel Cap of PM6-A, PM8-A - Square washer for PM6-A, PM8-A - Hexagonal bolt M20x210 - Hexagonal bolt M20x160 - Plain washer 20 - Washer 20 - Hexagon nut M20
	<p>ER-IC-ST Inter Clamp, Standard</p>	<ul style="list-style-type: none"> - Inter Module Clamp 28mm, 35mm, 38mm, 40mm, 46mm, 50mm, 57mm - 28mm with Hex Socket Head Bolt A2-70 M8 x 40mm - 35mm with Hex Socket Head Bolt A2-70 M8 x 45mm - 38mm with Hex Socket Head Bolt A2-70 M8 x 50mm - 40mm with Hex Socket Head Bolt A2-70 M8 x 50mm - 46mm with Hex Socket Head Bolt A2-70 M8 x 55mm - 50mm with Hex Socket Head Bolt A2-70 M8 x 60mm - 57mm with Hex Socket Head Bolt A2-70 M8 x 70mm - Z-Module - Washer 8
	<p>ER-EC-ST End Clamp, Standard</p>	<ul style="list-style-type: none"> - End Module Clamp 28mm, 32mm, 35mm, 38mm, 40mm, 42mm, 46mm, 48mm, 50mm - Z-Module - Hex Socket Head Bolt A2-70 M8 x 28 - Washer 8

PostMount 1/2/3-A for XL Panels

Robust pole mount system with adjustable angle for one, two and three XL panels

Clenergy's PV-ezRack® PostMount 1/2/3-A for XL Panels delivers flexible and durable designs to mount from one to three panels, up to 2100X1100mm per post. It's ideal for remote off-grid applications such as water pumps or small residential and commercial systems. The panel tilt is easily adjustable between 10° and 60° throughout the year and comes with hassle-free mounting thanks to patented components such as the PV-ezRack® rails and clamps. The combination of high quality aluminium, stainless steel and galvanised steel components make this a robust, reliable system with excellent corrosion resistance.

Main Benefits

Suitable for Every Soil Condition

With its concrete foundation, PostMount-A can be installed on even or uneven ground or on a slope, making it suitable for any soil type and a wide range of applications.

Adjustable Tilt Angle

The steel cap (post head) is designed to tilt panels between 10° and 60° to ensure that you get the required power output you need anywhere, anytime. Changing the angle merely requires a single pair of spanners.

Robust and Reliable

Mounted on aluminium rails the panels are supported by robust galvanised steel landscape and master tubes secured with stainless steel bolts. The post can be fixed into a concrete foundation and also used as a ramming option.

Quick and Easy Installation

Innovative and internationally patented, the Z-Module technology is used in almost all PV-ezRack® components. The Z-Module provides a quick, easy and safe installation method and can be inserted in to the rail at any given point, secured with just three hand grips.

**10 Year
Warranty**

Commercial

Residential

PM 1-A for XL Panels

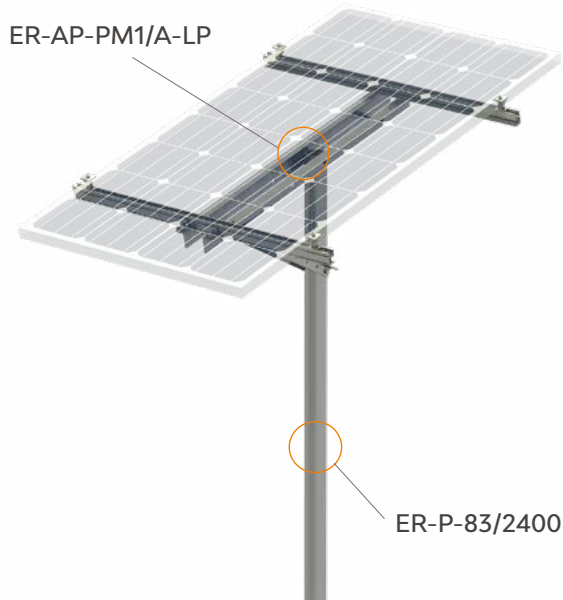

PM 2-A for XL Panels

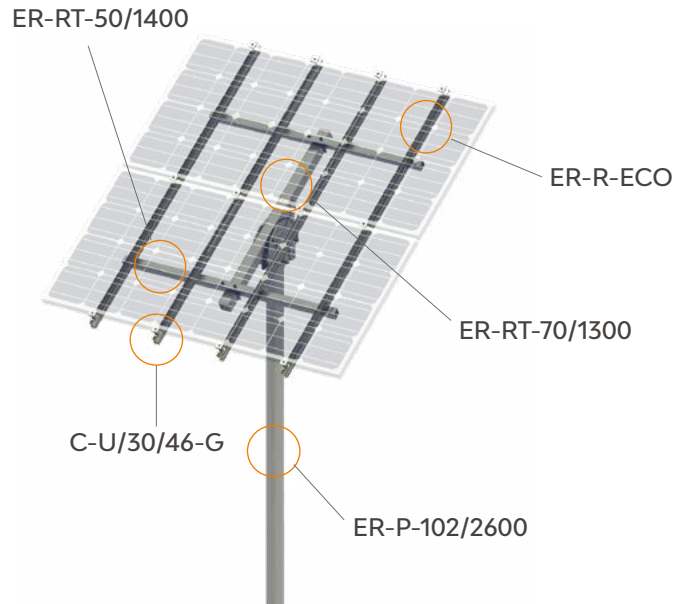



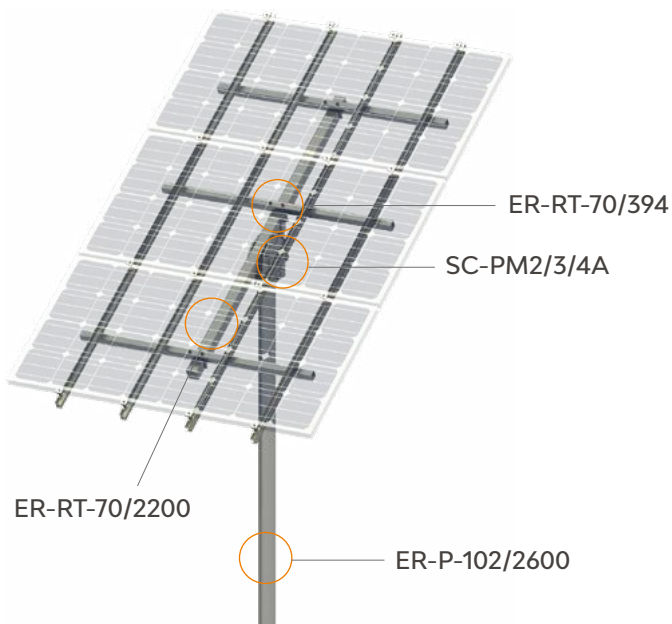



PM 3-A for XL Panels



Available accessories

- Grounding/earthing
- Cable clips
- Rail and Girder cap

Components

	<p>ER-P-102/2600 ER-P-83/2400 Pipe Diameter</p>	<ul style="list-style-type: none"> - Pipe Diameter Ø102x2600 (PM2,3-A for XL Panels Pole) - Pipe Diameter Ø83x2400 (PM1-A for XL Panels Pole)
	<p>ER-RT-50/1400 Rectangular Tube</p>	<ul style="list-style-type: none"> - Rectangular Tube-Landscape 50 x 50 x 1400
	<p>ER-R-ECO ECO-Rail</p>	<ul style="list-style-type: none"> - Aluminium profile of ECO-Rail - With standard lengths 3600mm and 4400mm
	<p>ER-RT-70/394 Adjustable Tube 70 x 50 x 394</p>	<ul style="list-style-type: none"> - Adjustable Tube 70 x 50 x 394 - Hexagonal bolt M14 x 120 - Hexagon nut M14 - Plain washer 14 - Washer 14
	<p>ER-RT-70/1300 ER-RT-70/2200 Rectangular Tube 70 x 70 x L</p>	<ul style="list-style-type: none"> - Rectangular Tube 70 x 70 x L
	<p>C-U/30/46-G Universal Clamp</p>	<ul style="list-style-type: none"> - Universal Clamp - Module for Universal Clamp - Grounding Clip for Universal Clamp - Hexagon socket button head screw M8 x 55 - Washer 8 - Spring for Universal Clamp
	<p>EZ-GL-ST Grounding Lug</p>	<ul style="list-style-type: none"> - Grounding Lug - Hexagon Socket Head Cap Screw M8 x 25 - Z Module - Washer 8 - Plain washer 8 - Grounding Lug Bolt - Copper Pipe for Grounding Lug



ER-AP-PM1/A-LP

PV-ezRack PM1-A,
Accessory Package

- Aluminum Profile Of ECO-rail 1150, L1150mm
- Angle Steel 63 x 40 x 1250 x T4mm
- Angle Steel 40 x 40 x 682 x T4mm, Right Supporting Rod
- Angle Steel 40 x 40 x 682 x T4mm, Left Supporting Rod
- Sleeve $\varnothing 20 \times 83 \times T3$ mm
- Cross Connection Clamp of ECO-rail, L40mm
- Cup Head Square Neck Bolts M8 x 25
- Hexagon Nut With Flange M8
- Hexagonal Bolt S M12 x 120
- Plain Washer 12mm
- Washer 12mm
- Hexagon Nut M12
- Universal Cable Clip for PV Panels for holding 2 cables



SC-PM2/3/4/A

Steel Cap Assembly

- Steel Cap of PM3-A, PM4-A
- Square washer for PM3-A, PM4-A
- Hexagonal bolt M14 x 150
- Hexagonal bolt M14 x 110
- Plain washer 14
- Washer 14
- Hexagon nut M14
- U washer T1.0 (for PM-A system)
- U washer T2.0 (for PM-A system)

PostMount 4/6-A for XL Panels

Robust pole mount system with adjustable angle for four and six XL panels

Clenergy's PV-ezRack® PostMount 4/6-A for XL Panels delivers flexible and durable designs to be mounted between four and six panels, up to 2100x1100mm per post. It's ideal for remote off-grid applications such as water pumps or small residential and commercial systems. The panel tilt is easily adjustable between 10° and 60° throughout the year and comes with hassle-free mounting thanks to patented components such as the PV-ezRack® rails and clamps. The combination of high quality aluminium, stainless steel and galvanized steel components make this a robust, reliable system with excellent corrosion resistance.

Main Benefits

Suitable for Every Soil Condition

With its concrete foundation, PostMount can be installed on even or uneven ground or on a slope, making it suitable for any soil type and a wide range of applications.

Adjustable Tilt Angle

The steel cap (post head) is designed to tilt panels between 10° and 60° to ensure that you get the required power output you need – anywhere, anytime. Changing the angle merely requires a single pair of spanners.

Robust and Reliable

Mounted on aluminium rails the panels are supported by robust galvanised steel landscape and master tubes secured with stainless steel bolts. The post can be fixed into a concrete foundation and also used as a ramming option.

Quick and Easy Installation

Innovative and internationally patented, the Z-Module technology is used in almost all PV-ezRack® components. The Z-Module provides a quick, easy and safe installation method and can be inserted into the rail at any given point, secured with just three hand grips.

**10 Year
Warranty**

Commercial

Residential

PM 4-A for XL Panels

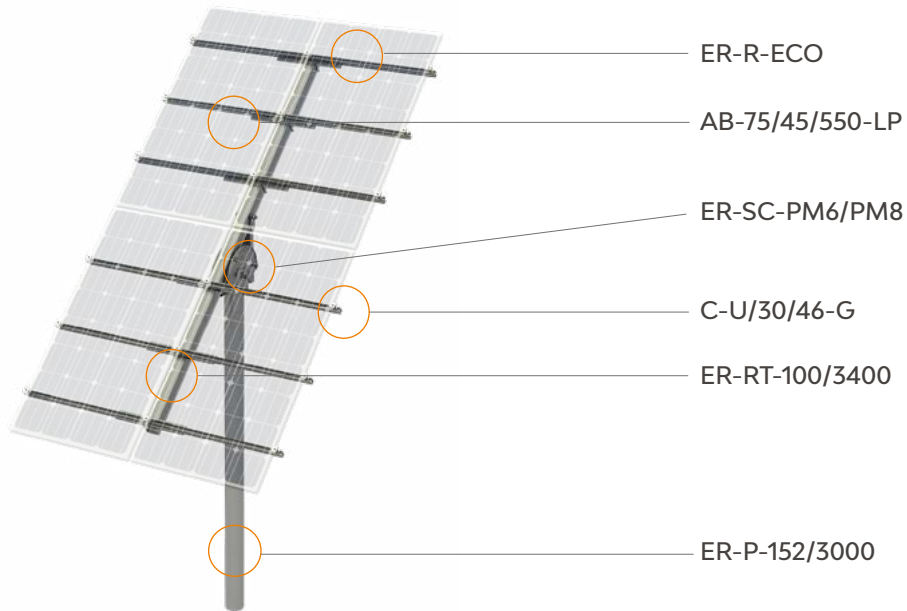



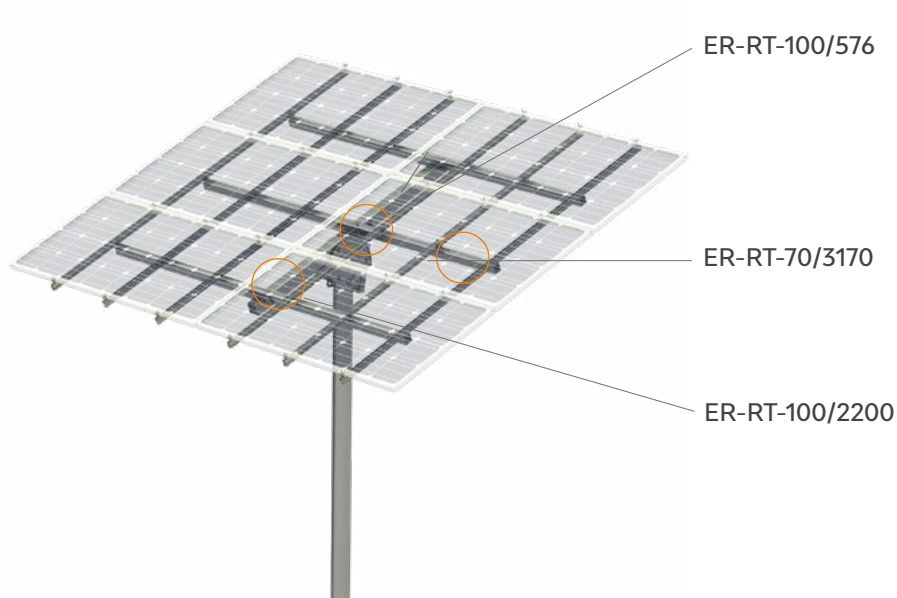



PM 6-A for XL Panels



Available accessories

- Grounding/earthing
- Cable clips
- Rail and Girder cap

Components

	<p>ER-P-152/3000 Pipe 152 x 3000 (PM6,8-A Pole)</p>	<ul style="list-style-type: none"> - Pipe Diamete Ø152 x 3000
	<p>ER-RT-70/3170 Rectangular Tube</p>	<ul style="list-style-type: none"> - Rectangular Tube-Landscape 70 x 70 x 3170
	<p>ER-R-ECO ECO-Rail</p>	<ul style="list-style-type: none"> - Aluminium profile of ECO-Rail - With standard lengths 3600mm and 4400mm
	<p>ER-RT-100/576 Adjustable Tube 100 x 50 x 576</p>	<ul style="list-style-type: none"> - Adjustable Tube 100 x 50 x 576 - Hexagonal bolt M20 x 160 - Hexagon nut M20 - Plain washer 14 - Washer 20
	<p>ER-RT-100/2200 Rectangular Tube 100 x 100 x 2200</p>	<ul style="list-style-type: none"> - Rectangular tube 100 x 100 x 2200 with pre-welded angle
	<p>C-U/30/46-G Universal Clamp</p>	<ul style="list-style-type: none"> - Universal Clamp - Module for Universal Clamp - Grounding Clip for Universal Clamp - Hexagon socket button head screw M8 x 55 - Washer 8 - Spring for Universal Clamp
	<p>EZ-GL-ST Grounding Lug</p>	<ul style="list-style-type: none"> - Grounding Lug - Hexagon Socket Head Cap Screw M8 x 25 - Z Module - Washer 8 - Plain washer 8 - Grounding Lug Bolt - Copper Pipe for Grounding Lug



AB-75/45/550-LP
Angle Bracket 75 x 45 x 550

- Postmount4-A Angle Bracket 75 x 45 x 550
- U bolt M10x140 (with 100 x 100 tube)
- Plain washer 10
- Washer 10
- Hexagon nut M10
- Hexagon socket head cap screw M8 x 28
- Plain washer 8
- Washer 8
- Hexagon nut M8
- Cross connection clamp



ER-RT-100/3400
Rectangular tube 100 x 100 x 3400

- Rectangular tube 100 x 100 x 3400



ER-SC-PM6/PM8
Steel Cap Assembly

- Steel Cap of PM6-A, PM8-A
- Square washer for PM6-A, PM8-A
- Hexagonal bolt M20 x 210
- Hexagonal bolt M20 x 160
- Plain washer 20
- Washer 20
- Hexagon nut M20

ezShade

The universal ground mounted solution

Clenergy PV-ezRack® ezShade is an economical ground mounted system for landscape module installations that provides shelter for parking. It is designed for high wind speed and snow loads. The combination of Clenergy's patented aluminium base rail, Z-module technology and rail splicing saves you the trouble of on-site cutting for fast installation. The anodised aluminium components combined with this specific structural design result in an optimal balance between aesthetics and cost effectiveness.

Main Benefits

Customized Solution

We offer customized solution for PV-ezRack® ezShade with optional one-car span or two-car span. Both silver anodized and black anodized products are available.

Durability

The whole anodised aluminium structure gives the system a decent look and anti-corrosive quality as well. It is a good choice for even the toughest environment, such as sites near the coastline.

Watertight Function

PV-ezRack® ezShade is available with the watertight function for the premium product. The version without it is the more economical option.

System Earthing Feature

With the earthed panel clamps, T-rail clamps with earthed Z-modules and set screws in the system, it can create earthing continuity from solar panels to supports.

**10 Year
Warranty**

Utility

Commercial

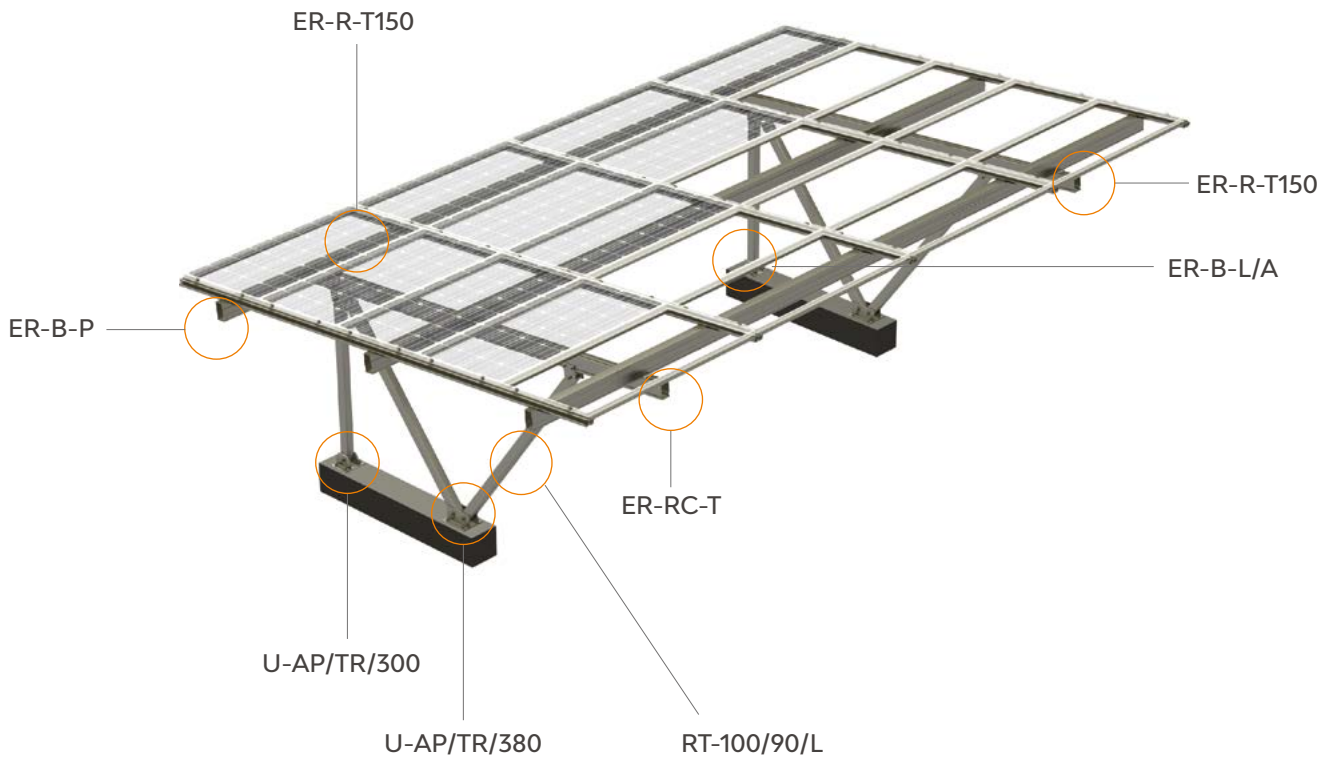









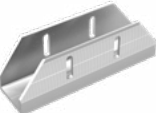



Available accessories

■ Grounding/earthing

■ Rail and Girder cap

Components

	<p>U-AP/TR/300 Corrugated U-anchor Plate</p>	<ul style="list-style-type: none"> - Corrugated U-anchor Plate 300 - Hexagonal bolt M16 x 150 - Plain washer 16 - Washer 16 - Hexagon nut M16 - Corrugated Shim 50 x 40 x 6 - Bushing Ø23 x 77.5 - Hexagonal bolt M16 x 130
	<p>U-AP/TR/380 Corrugated U-anchor Plate</p>	<ul style="list-style-type: none"> - Corrugated U-anchor Plate 380 - Hexagonal bolt M16 x 150 - Plain washer 16 - Washer 16 - Hexagon nut M16 - Corrugated Shim 50 x 40 x 6 - Bushing Ø23 x 77.5 - Hexagonal bolt M16 x 130
	<p>RT-100/90/L Rectangular Tube</p>	<ul style="list-style-type: none"> - Rectangular Tube 100 x 90 x Lmm
	<p>ER-SP-T150 Splice for T-150 Rail</p>	<ul style="list-style-type: none"> - Splice for T-150 Rail 125.5 x 57.2 x 500 - Corrugated Shim 60 x 6 x 500 - Sharp-Point wood screw ST6 x 32
	<p>SPII-B150 Splice II for Main Support Beam</p>	<ul style="list-style-type: none"> - 90x40x200 - Cup head square neck bolts M8 x 30mm - Plain washer 8 - Washer 8 - Hexagon nut M8
	<p>ER-R-T150 T-Rail, 150</p>	<ul style="list-style-type: none"> - 4200mm - 2360mm
	<p>ER-B-L Dry Bar-Landscape(with Bushing)</p>	<ul style="list-style-type: none"> - Dry Bar-Landscape 43 x 42 x 1623 43 x 42 x 1637 43 x 42 x 1687 43 x 42 x 2095 - Rubber for Dry Bar 6.8 x 3.9 x 1750 - T head bolt - Hexagon nut M6 - Curved spring washer Ø6.7 - Bushing

	<p>ER-B-L/A Dry Bar-Landscape</p>	<ul style="list-style-type: none"> - Dry Bar-Landscape 43 x 42 x 1623 43 x 42 x 1637 - Rubber for Dry Bar 6.8 x 3.9 x 1750 - T-head bolt M6 x 55 - Hexagon nut M6 - Curved spring washer Ø6.7
	<p>ER-B-T6/65 T bolt kit</p>	<ul style="list-style-type: none"> - T-head bolt M6 x 65 - Washer Ø6.5 - Hexagon nut M6
	<p>ER-B-P Dry Bar-Portrait 5105</p>	<ul style="list-style-type: none"> - Dry Bar-Portrait 32 x 11.5 x 5105 - Rubber for Dry Bar 6.8 x 3.9 x 5200
	<p>ER-CC-B/L Cross Connection for Dry Bar-Landscape</p>	<ul style="list-style-type: none"> - Cross Connection for Dry Bar 52 x 42 x 42
	<p>ER-CAP-B/P End Cap for Portrait Dry Bar</p>	<ul style="list-style-type: none"> - End Cap for Portrait Dry Bar 32 x 12 x 15
	<p>ER-CAP-B/L Top Cover for Landscape Dry Bar</p>	<ul style="list-style-type: none"> - Top Cover for Landscape Dry Bar 18.4 x 10 x 1623 18.4 x 10 x 1637 18.4 x 10 x 1687 18.4 x 10 x 2095
	<p>ER-B-150 Main Support Beam</p>	<ul style="list-style-type: none"> - Main Support Beam 150 x 31.2 x Lmm



Accessories

Earthing / Grounding components



EZ-GL-ST
Grounding Lug (standard)

- Grounding Lug L25
- Hexagon Socket Head Bolt M8 x 25mm
- Z-Mouldle L20
- Spring Washer M8.4
- Flat Washer M8.4
- Grounding Lug Bolt M6 x 14mm



EZ-GL-ST/UC
Grounding Lug, with U-Shape Copper Channel

- Grounding Lug, with Clenergy logo
- Hexagon socket head cap screw M8 x 25
- Z Module (Anodized)
- Washer 8
- Plain washer 8
- Grounding Lug Bolt II M6 x 14
- U-Shape Copper Channel



EZ-GC-ST
Grounding Clip (standard)

- Grounding Clip (standard)

Cable clips and trays



CC-R/ECO/6
AL Cable clip for ECO-Rail

- AL Cable clip for ECO-Rail
- Install tool for AL Cable clip



EZ-CC-PV/2
Universal Cable Clip for PV Panels for holding 2 cables



EZ-CC-PV/2/L
Universal Cable Clip for PV Panels for holding 2 cables, Landscape



EZ-CC-PV/4
Universal Cable Clip for PV Panels for holding 4 cables



EZ-CC-PV/4/L
Universal Cable Clip for PV Panels for holding 4 cables, Landscape



EZ-CD-102
Cable Duct 102



EZ-CO-CD/102
Cover for Cable Duct 102



EZ-C-CD/T
Clamp for Cable Duct on T-Rail

- Clamp for Cable Duct on T-rail
- T-head bolt M8 x 25mm
- Plain washer 8mm
- Washer 8mm
- Hexagon nut M8
- Set screw M8 x 12mm

Rail caps



ER-CAP-T110
Cap for T-Rail 110



ER-CAP-G/A
Cap for Square Girder



EZ-CAP-T50
Cap for T-Rail 50



CAP-ECO/PA
CAP-ECO/PA/BA
Cap for ECO-Rail



Brackets for inverter / combiner box



EZ-UB-STIIIA
SolarTerrace III-A, Bracket kit
for Inverter / Combiner Box

- U-Fixing Bracket for Tube 60 x 60mm
- T-head bolt M8 x 25mm
- Plain washer large 8 x 24mm
- Washer 8mm
- Hexagon nut M8
- Self-drilling screw ST6.3 x 25mm



EZ-UB-STIIA
SolarTerrace II-A, Bracket kit for
Inverter / Combiner Box

- U-Fixing Bracket for Tube 60 x 60mm
- T-head bolt M8 x 25mm
- Plain washer large 8 x 24mm
- Washer 8mm
- Hexagon nut M8



EZ-RT-60/60/740
Slotted Al-Tube for Bracket kit
for Inverter / Combiner Box



- Slotted Al-Tube 60 x 60 x 740mm









ER-R-C41/61/800
C-Channel for Bracket kit for
Inverter / Combiner Box

- 41 x 62 x 800mm









Rubber pads

	<p>EZ-RB-60/45/12 EPDM rubber pad</p>	<ul style="list-style-type: none"> - EPDM rubber pad 60 x 45 x 12mm
	<p>EZ-RB-ST Rubber Pad</p>	<ul style="list-style-type: none"> - 50 x 25 x 2.2mm
	<p>EZ-RB-60/20000/2 EPDM strip</p>	<ul style="list-style-type: none"> - EPDM strip 60 x 20000 x 2mm

Other

	<p>EZ-AD-C110 SolarRoof Adapter for Corrugated Iron Roof</p>	<ul style="list-style-type: none"> - AL Adapter 110mm x 124mm - EPDM rubber pad - Z-Module and bolt
	<p>EZ-Z-STBW Z-Module assembly with bolt and washer</p>	<ul style="list-style-type: none"> - Z-Module - M8 x 25mm A2 70 - Washer 8.4mm DIN 9021 A2 - Lock Washer 8mm A2
	<p>EZ-Z-ST Z-Module</p>	
	<p>EZ-RE-200 Roof Hook Extender</p>	<ul style="list-style-type: none"> - 200mm Roof Hook Extender - Hex Socket Head Bolt - Hex Nut
	<p>ER-R-MT/2560 MT-rail</p>	<ul style="list-style-type: none"> - With a standard length of 2560mm
	<p>ER-DM-MT8 Diamond module M8 with Hexagon Socket bolt M8 x 20 (for AU)</p>	

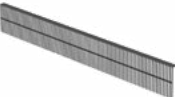
	<p>CM-01 Click Module without Bolt</p>	<ul style="list-style-type: none"> - Main Click Module - Side Click Module - Spring for Click Module 	
	<p>CM-01/B Click Module with Bolt</p>	<ul style="list-style-type: none"> - Main Click Module - Side Click Module - Spring for Click Module - Washer 8 - Lock Washer M8 x 18 - socket head cap screw M8 x 25 	
	<p>IS-SR265/111 IS-SR265/111/B Isolator Shade, 280 x 158 x 114mm with Z-Module and bolt, non-assembly</p>	<ul style="list-style-type: none"> - Isolator Bracket, 265 x 155 x 111.5mm - Isolator Cover, 280 x 155.5 x 114mm - Z Module (Anodized, grounding) - Plain washer large 8 x 24 - Washer 8 - Hexagon socket head cap screw M8 25 - Cross Recessed Countersunk Head Tapping Screws ST3.5 x 16 - Grounding Lug Bolt - Washer 6 - Hexagon nut M6 - External Teeth Lock Washer 12 (for Black Anodized) - External Teeth Lock Washer 8 (for Black Anodized) 	
	<p>AB-SR/IS/260 AB-SR/IS/260B Angle Bracket for Isolator Shade, 260mm Length</p>	<ul style="list-style-type: none"> - Angle Bracket for Isolator Shade, 260mm Length - Hexagon nut M8 - Washer 8 - Hexagon socket head cap screw M8 x 25 - External Teeth Lock Washer 8 	
	<p>CRC-R/ECO-ZBW Cross Connector Clamp of ECO-Rail with Z-module</p>	<ul style="list-style-type: none"> - Hexagon socket head cap screw M8 x 25 - Washer 8 - Cross Connector Clamp of ECO-Rail - Z Module 	
	<p>CRC-R/ECO Cross Connector Clamp of ECO-Rail</p>	<ul style="list-style-type: none"> - Cross Connector Clamp of ECO-Rail 	
	<p>RC-ECO/G PVezRack® Rail Clamp for ECORail with grounding / earthing pins</p>	<ul style="list-style-type: none"> - Hexagon socket head cap screw M8 x 30 - Washer 8 - Rail Clamp for ECO-Rail with grounding / earthing pins - Z Module 	
	<p>ER-HB-8/150 Hanger Bolt for wood purlin, M8 x 150</p>	<ul style="list-style-type: none"> - Hanger Bolt for wood purlin, M8 x 150 (with 3 nuts, round EPDM rubber pad, mounted) - Waterproof Gasket for Hanger bolt M8 - Hexagon nut with flange M8 	

	<p>ER-HB-MP/8/150EP PV-ezRack Hanger Bolt for metal purlin M8 x 150mm</p>	<ul style="list-style-type: none"> - Hanger Bolt for metal purlin M8 x 150 - Waterproof Gasket for Hanger bolt M8 - Hexagon nut with flange M8
	<p>US-6.3/70-BW/BX Self-drilling Universal Screw, Buildex 14-11 x 70 Hex Head Zips Climaseal 3 with 16 mm ABW</p>	
	<p>ER-HB-10/200A Hanger Bolt M10 x 200mm</p>	<ul style="list-style-type: none"> - Hanger Bolt M10 x 200 - Waterproof Gasket for Hangerbolt M10 x 200 - Hexagon nut with flange M10
	<p>GE-STA/200 Girder Extension for SolarTerrace-A (II and III) 200mm</p>	<ul style="list-style-type: none"> - Splice for Tri-Groove Square Girder - Flange Facing Self-Tapping Screw (washer) ST6.3 x 22 - Alum profile of tri-groove Beam 200
	<p>GS-76/3.5/4/F0 Ground Screw, with Quadrate Flange and Continuous Small blade</p>	<ul style="list-style-type: none"> - $\varnothing 76 \times 3.5 \times 1300\text{mm}$ - $\varnothing 76 \times 3.5 \times 1600\text{mm}$
	<p>EZ-CT-40/40/2560 Cable Tray</p>	<p>40 x 40 x 2560 mm</p>
	<p>CO-MT/855 Cover for MT-Rail</p>	<p>length 855mm</p>
	<p>EZ-SS-PV DFendr - Solar Skirt for PV Panels</p>	 <p>EZ-SC-PV DFendr - Solar Skirt Clip for PV Panels</p>

10 Year Product Warranty

As the manufacturer of quality solar mounting systems, Clenergy Australia provides a warranty for all PV-ezRack® products it supplies in Australia and New Zealand (“**Products**”). The warranty provided by Clenergy Australia is subject to the conditions contained in this document (“**Warranty**”). No other warranty provision implied or otherwise is to be assumed. Your Warranty coverage is in accordance with this document.

Product Warranty Table for Installations in Corrosivity Category 1, 2, 3, 4 and 5 (ISO 9223)

Product	Material	Standard or Customized Product	Product Warranty		
			Corrosivity Category 1, 2 and 3	Corrosivity Category 4	Corrosivity Category 5
1	Aluminium Components	6005CL-T5 mill finish	10 years	10 years*	
		6005-T5 anodized to 10 microns			
		6005-T5 anodized to 15 microns		10 years*	
		6005-T5 anodized to 20 microns			
2	Galvanized Steel Components	Galvanized Steel at 85 microns in average	10 years	10 years	Not warranted
3	Stainless Steel Components	SUS304			10 years
4	Fasteners (bolts/nuts/washers)	SUS304		Standard	
		SUS316			Customized
5	Screws for Tile Interface	Carbon Steel SAE 1022 with Climaseal C3 Rated Finish	10 years	10 years**	
6	Screws for Tin Interface	Carbon Steel with C3 Rated Finish		Standard	Not warranted
		Carbon Steel with C5 Rated Finish	30 years		25 years

* Subject to interface spacing reduction as advised by Clenergy Australia. Please contact us for more details.

** The screws under tile interface are assumed to be installed in category 1, 2 or 3 micro-climate within the roof structure.

Warranty Scope

Your solar mounting Product has been manufactured to high standards, however, should any manufacturing defect arise, please contact Clenergy Australia. We will arrange for an inspection of the affected Product(s) to determine the extent of the problem.

Details are provided below as to the extent of your Warranty coverage and any exclusions that may apply. Please read these provisions carefully to ensure you receive the appropriate assistance and support in a timely manner. Please also contact Clenergy Australia if any part of this Warranty is unclear, or you wish to discuss your rights and remedies under this Warranty.

If your Product fails during the Warranty periods set out in the Warranty table above due to a defect in:

(a) materials and/or workmanship on and from the date of the Product's delivery; or

(b) structural integrity on and from the date of the Product's installation,

Clenergy Australia will at its election (after proof of purchase has been confirmed) either repair or resupply the defective Product provided that:

- The Product was installed correctly by a Clean Energy Council ("CEC") accredited or equivalent accreditation installer, following the Clenergy installation manual provided at time of purchase.
- The Product has been maintained correctly in accordance with section "Care of your Product" below.

Warranty Conditions

- Any and all costs for repair or replacement outside the Warranty period are the responsibility of the customer.
- Where Clenergy attends a site and finds that the Product is not faulty, the costs for the visit will be payable by the customer.
- Defective Products shall be uninstalled and/or reinstalled at the customer's expense and risk.
- Under certain conditions, the Warranty can be extended to more than 10 years at an extra cost, available upon request.

Warranty Exclusions

- Product finish (natural surface oxidation) or any natural impairment or surface corrosion that does not compromise the structural integrity.
- Products sold or installed outside of Australia and New Zealand unless approved previously in writing by Clenergy Australia.
- Damage caused by transport, mishandling, incorrect storage, improper loading or willful conduct.
- Any Product not correctly installed in accordance with our installation manual, or any specific design instruction or special conditions as advised by Clenergy Australia.
- Damage caused by the Product being modified in any way unless previously agreed to in writing by Clenergy Australia.
- The use of the Product for purposes other than the mounting of PV solar panels.
- Installations where the environment is excluded in the "Products Warranty Table" above, and for galvanized steel ground system Products, where the pH level is outside the range of 6-8, unless agreed to in writing by Clenergy Australia prior to installation.
- Damage caused by extreme weather conditions or any other natural or man-made event outside of our control.
- Damage caused by attachments not designed or approved for connection to the Product.
- Damage caused by lightning strikes or excessive currents through the earthing/grounding clamps, clips or lugs.

Our Products may come with guarantees that cannot be excluded under the Australian Consumer Law. You may be entitled under statute to a replacement or refund for a major defect in the Products. You may also be entitled under statute to have the products repaired for any defect which does not amount to a major defect. The benefits given by this Warranty are in addition to any statutory rights and remedies you may have under Australian law.

Product Care

Clenergy Products are designed to be durable with minimal care, however it is important that you maintain your mounting Product in accordance with proper practices. This includes regular maintenance and inspection to avoid damage.

The aluminum components are made from either AL 6005CL-T5 or AL6005-T5 and may also have a clear anodization. The aluminum may undergo some surface oxidization in service. Please note that this is normal and part of the natural ageing process. The result may even be beneficial to the longevity of the Product, as the oxidization can provide additional protection against degradation by pollution and atmospheric corrosion.

- You should also ensure that if the Product is stored prior to installing that it is not contaminated by contact with rusty items or other impurities such as dirt and chemicals. Should this occur, you must clean the Product and make any repairs using approved methods such as galvanized paint and antirust treatments immediately before installation. Steel components should be inspected before and after installation and any damage to the galvanizing should be treated immediately to prevent rusting. It is normal for galvanized Products to develop a surface barrier (the 'patina'), which helps to protect the surface from contaminants in the atmosphere and does not adversely affect the Product.
- The torque values of fastener connections on mounting system must be checked annually and corrected if needed in accordance with Clenergy Australia's installation manual.
- Regular cleaning to remove any soil or other possible contaminants must also be performed. Cleaning should be performed in accordance with guidelines recommended by the Standards Association of Australia (AS 1231-2000) (for aluminium Products) and the Galvanizers Association of Australia (GAA) (for steel Products supplied in Australia) or the Galvanizers Association of New Zealand (GANZ) (for steel Products supplied in New Zealand) or any other similar organisations (as applicable). When using tin interfaces for installation works, screws not exposed to frequent rain should be washed down with fresh water at least every 6 months.

Merch Store



Merch Store



MERCHANDISING







PV-ezRACK®

Clenergy

1/10 Duerdin St
Clayton VIC 2168
Australia

Phone: +61 3 9239 8088
Email: sales@clenergy.com.au
Web: www.clenergy.com.au

 @ClenergyGlobal / @ClenergyClub / ClenergyAUS  @Clenergy  @ClenergyClub
 @Clenergy_global  @Clenergy

A Clenergy Technologies Company

